

The logo consists of the word "FATEK" in a bold, white, sans-serif font, centered within a solid red rectangular background.

*FBs-CBEH*

**Multifunction Ethernet**

**Communication Board**

Operation Manual

V1.1

12/05/2012

FATEK AUTOMATION CORP.

---

## Table of Contents

Chapter 1 Introduction to CBEH Multifunction Ethernet Communication Module .....	4
1.1 Summary .....	4
1.2 Main Product Functions .....	4
1.3 Product Features .....	5
1.4 Manual Reading Guidance .....	6
1.5 Product Appearance .....	7
1.6 Companionate Softwares .....	8
Chapter 2 PLC and CBEH Communication Interfaces .....	10
Chapter 3 CBEH Basic Configuration Settings .....	12
3.1 Setting CBEH through the Ether_Config software .....	12
3.1.1 Connecting To CBEH Through LAN .....	13
3.1.2 IP Address Setting .....	15
3.1.3 Operation Mode Setting .....	16
3.1.4 Access Control .....	16
3.1.5 Port Mapping .....	17
3.1.6 Service Ports .....	19
3.1.7 Password .....	19
3.1.8 External Servers .....	20
3.1.9 Offline Configuration Setting .....	21
3.2 Setting CBEH Through Web Browsers .....	23
3.2.1 System Page .....	24
3.2.2 IP Address Setting .....	25
3.2.3 Operation Mode Setting (Port2 Setting) .....	27
3.2.4 Access Control .....	27
3.2.5 Port Mapping .....	28
3.2.6 Service Port .....	29
3.2.7 Password .....	30
3.2.8 External Servers .....	31
Chapter 4 Customized Web Page Design .....	33
4.1 Changing Web Page Style .....	33
4.2 Adding Menus .....	37
4.3 Add Contents .....	39
4.4 Sending User's Webpage to CBEH .....	53
4.5 Setup optional parameters .....	55
Chapter 5 Sending Emails, Email to SMS .....	59

Chapter 6 Internet Clock Synchronization .....	65
6.1 Enable the Internet Clock Synchronization Function.....	65
6.2 Synchronization of Real Time Clock with Network Time.....	66
6.3 Sample Application .....	67
Chapter 7 Monitoring PLC's Internal Status Using The CBEH System Webpage .....	68
7.1 Adding Monitoring Points .....	68
7.2 Modifying and Deleting Monitoring Points .....	69
7.3 Modify the Value of Monitoring Point .....	70
Chapter 8 Active Call Back.....	71
8.1 Option Setting Page .....	71
8.2 Guest List.....	72
8.3 Active Call Back Application Example .....	73
Chapter 9 CBEH Firmware Update .....	75

# Chapter 1 Introduction to CBEH Multifunction Ethernet Communication Module

## 1.1 Summary

FBs-CBEH is a compact communication expansion board that does not take up additional module space. Through this expansion board, the FBs-CPU module can communicate actively (client mode) or passively (server mode) with the controllers through Ethernet. This expansion board is compatible with all FBs-CPU modules. Through this expansion board, the goal of remote PCL monitoring and diagnostics can be easily accomplished.

Communications Port1 and Port2 will be used when this expansion board is applied. Port1 is fixed as FATEK Slave operation mode and can be used for the editing and debugging of ladder programs. Port2 is used to support the Modbus-TCP or FATEK client operation mode. When operating, the parameters of communication ports Port1 and Port2 will be configured automatically according to the work mode set.

In addition to the functions mentioned above, this product also provides a web server function; besides providing the function of setting the module's configuration contents through a web browser, it also provides user with the ability to custom design a webpage that is easy to operate. Through this function, the user can use the customized webpage to easily browse or control the status within the PLC.

The difficulty to grasp and the too-specialized internet firewall setting of dynamic IP have always been problems faced by internet remote maintenance applications. This product provides an active remote service call back function that can completely eliminate these problems. If only used for remote maintenance, under most circumstances, it can be immediately used without the need to setup.

When a situation arises on-site, the Email sending function of this expansion board can be used to notify the remote maintenance personnel, or use the Email to SMS internet service to provide a more real-time SMS(Text) messaging to notify the maintenance personnel.

## 1.2 Main Product Functions

### PLC internet data communication

The FBs-CBEH expansion board provides a PLC internet connection solution, achieving Fatek or Modbus protocol data communication applications through this expansion board's Port1 and Port2.

### Customized web page design

The FBs-CBEH expansion board provides a web server function; in addition to the built-in system webpage, it also allows user to easily browse or control the status

within the PLC through a customized web page. This customized web page can be easily designed by using the companionate software “Easy Web Designer”; it does not require any knowledge of HTML language or programming skill used for web pages design.

#### Email sending

For a more responsive maintenance requirement, the FBs-CBEH expansion board provides the Email sending function. When special situations occurred on the workstation, the ladder program can issue the “send Email command” to the CBEH and further send an Email to notify the maintenance personnel. In addition, through Internet service provider that provides “Email to SMS” sending functions, real-time notifications by SMS also can be achieved.

#### Internet clock Synchronization (SNTP, Simple network time protocol)

The FBs-CBEH expansion board provides the internet clock synchronization function, eliminating the trouble of manually correcting the time on a regular basis.

#### Remote maintenance-Active call back

Provides the software “Service Call Center” to help the execution of remote maintenance task. While establishing the connection between maintenance center and remote node, “active call back” method avoids the necessity of IP setting of remote node, It’s quite helpful especially when the PLC IP address is acquired by the dynamic IP method (DHCP), or if in a more complicated network environment that is difficult to acquire the IP.

### 1.3 Product Features

- Supports Multi-Client simultaneous access function.
- Provides Modbus Server or Client operation modes \*<sub>1</sub>.
- Provides Fatek Server and Client\*<sub>1</sub> operation modes.
- 10/100 BaseT Ethernet interface.
- IP access restriction security mechanism.
- Provides web server function.
- Module configuration setting can be done through web browsers\*<sub>2</sub>.
- Provides the EasyWeb fixed-template web page design tool. Users can custom-design the operation webpage without the need to have webpage related skills.
- Remote maintenance active call back function, eliminating the trouble of internet settings.
- Provides internet clock synchronization (SNTP) functions, eliminating the trouble of manually correcting the time on a regular basis.
- Provides Email sending function. Through the Email to SMS internet service it can also achieve the goal of sending SMS.

#### Note\*<sub>1</sub>



1. When Fatek client function is selected, it does not provide the Modbus server or client function.
2. Applicable web browsers - IE 9.0 、 Firefox 16.0.2 、 Google Chrome 23.0 、 Opera12.02 、 Safari5.1.7 or above.

### 1.4 Manual Reading Guidance

The FBS-CBEH expansion board has a lot of functions, but most of the functions are independent. When apply the functions, you do not have to read the entire manual, just the explanations in related chapters. For example, if you are only going to use the basic Fatek internet data communication application, then you only need to read Chapter 3.

## 1.5 Product Appearance

The introduction to the FBs-CBEH expansion board's appearance and function parts are as follows:

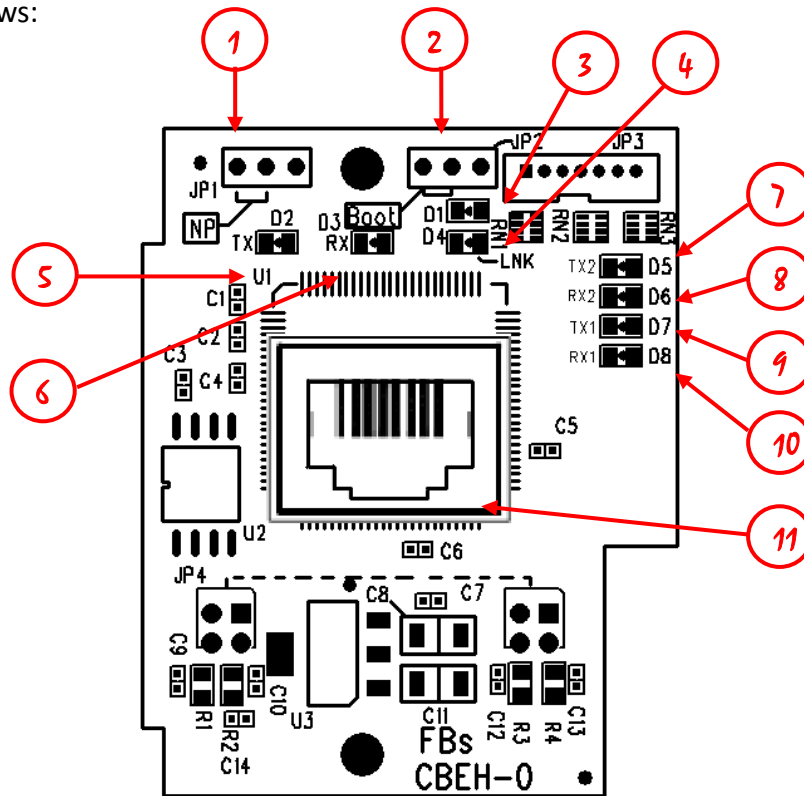

- ① NP jumper: When the jumper is set on the left two pins, it is not password-protected.
- ② Boot jumper: When the jumper is set on the left two pins, it will be forced to enter Boot operation mode when started up.
- ③ Expansion board status indicator (Run): When operating normally, this indicator will flicker rapidly; when entered the Boot operation mode, this indicator will flicker slowly.
- ④ Ethernet status indicator (Link): When this is on, it means that the internet connection is normal.
- ⑤ Ethernet transmitting status indicator (Tx): When this is on, it means that the expansion board is currently sending message to the Ethernet.
- ⑥ Ethernet receiving status indicator (Rx): When this is on, it means that the expansion board detected that there are messages appear on the Ethernet.
- ⑦ CPU module's Port2 TX red signal indicator: When this is on, it means that there are messages being sent to this expansion board from Port2 of the CPU module.
- ⑧ CPU module's Port2 RX green signal indicator: When this is on, it means that Port2 of the CPU module received the messages sent by this expansion board.
- ⑨ CPU module's Port1 TX red signal indicator: When this is on, it means that there are messages being sent to this expansion board from Port1 of the CPU module.
- ⑩ CPU module's Port1 RX green signal indicator: When this is on, it means that Port1 of the CPU module received the messages sent by this expansion board.
- ⑪ Ethernet connector: RJ45 standard connector.

## 1.6 Companionate Softwares

### ➤ Ether Config

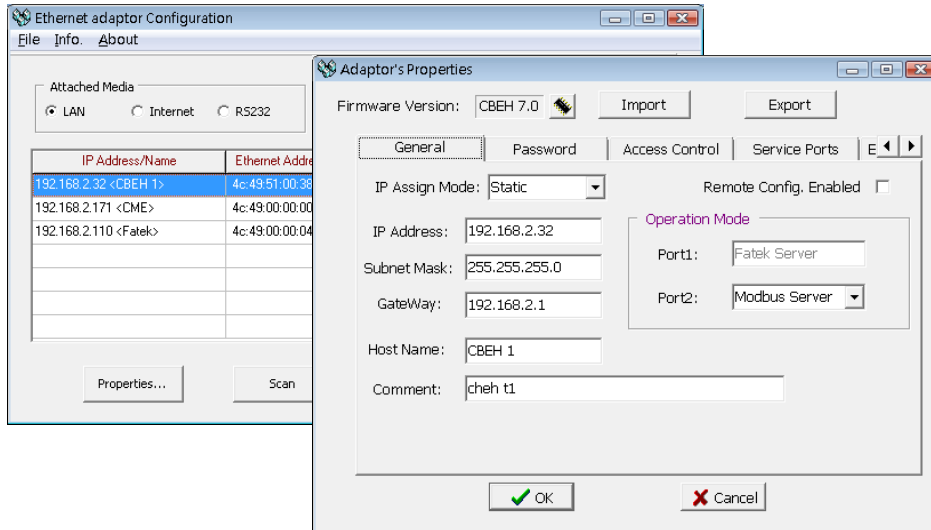

An application that works with the FBS-CBEH expansion board provides a window-based configuration software, used to set the module's basic settings, password protection and firmware update etc. Please refer to Chapter 3.1 for detailed explanation.

### ➤ Easy Web Designer

The Easy Web Designer has the following two functions:

1. Create customized web pages

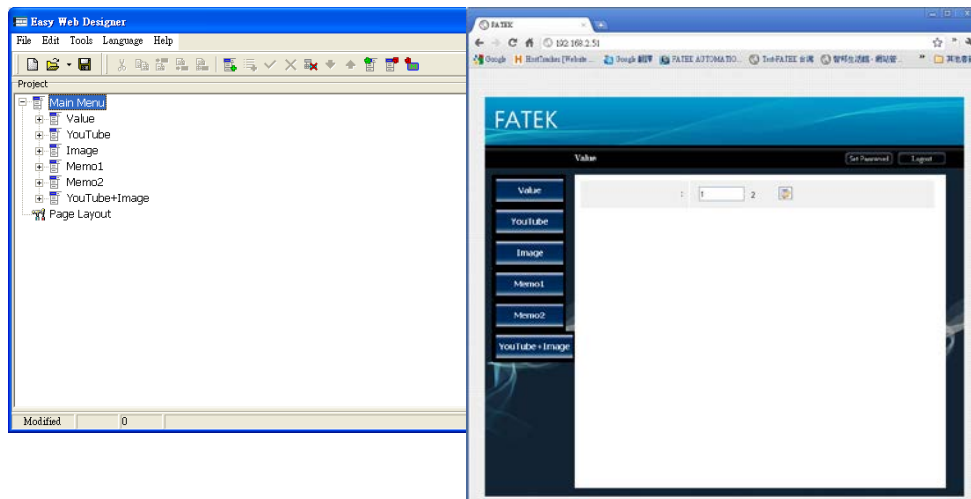

The FBS-CBEH expansion board provides the function to allow users to easily browse or control the status within the PLC through a customized web page; the customized web page can be created through this software without requiring the user to have the skills to write HTML. Please refer to chapter 4 for detailed explanation.



## 2. Email sending data setting

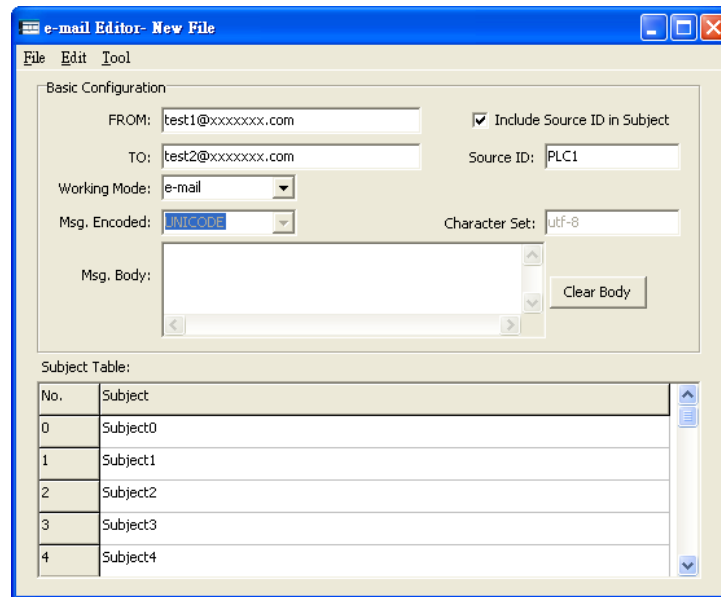

In terms of maintenance immediacy, the FBs-CBEH expansion board provides the Email sending and Email to SMS functions, which can be set through the windows tool "Email Editor" in Easy Web Designer. Please refer to chapter 5 for detailed operation contents.

### ➤ Service Call Center

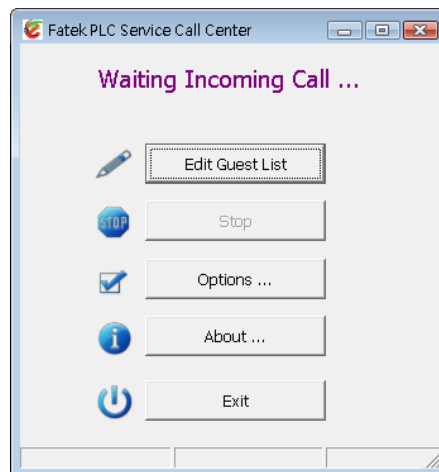

The Service Call Center software is provided to work with remote maintenance operations, used to perform maintenance tasks when the PLC workstation's IP is acquired with the dynamic IP method or when it is in a more complicated network environment and the IP is difficult to acquire. Please refer to Chapter 8 for detailed operation contents.

## Chapter 2 PLC and CBEH Communication Interfaces

The communication interface between the PLC module and the CBEH communication module is via the CPU registers D3950~D3999. The functions for each register in this area are described as follows:

Active Call Back		
Register	Description	
D3950 (CPU written* <sub>1</sub> )	Active call back and initialization setting command code	
	Setting value	Function
	0x3359	Execute active call back, value zero must be entered when terminating connection.
	0x3450	Reset CBEH module. When the local machine's internet parameter is changed, it can reset without powering off; will be changed to zero after the command is executed.
	0x3451	Resets the CBEH module to factory settings. Will be changed to zero after the command is executed.
D3951	Call Status	
	Content value	Status
	0	Standby
	1	Connecting
	2	Connected
	5	Connection failed
	6	Connection denied
	7	Verifying
	8	Connection terminated
Internet Clock Synchronization		
Register	Description	
D3952 (CPU written* <sub>1</sub> )	daylight time	Set whether to use daylight saving time now 0 – Standard time 1 – Daylight saving time
D3953	NTP Calendar	Second
D3954		Minute
D3955		Hour
D3956		Day
D3957		Month
D3958		Year
D3959		Week Day
D3960	Update Flag	Update flag. NTP Calendar updates once every ten minutes; the flag value increases by 1 after every update. Synchronization time can be determined by detecting the changes of this flag.

Note\*<sub>1</sub>: The values in this table is written by the CPU. For register ranges D3978~D3989 and D3991~D3999, only D3990 is written by the CPU during 0x4951, all others are written by the CBEH.

Email Sending		
Register	Description	
D3961 (CPU Written <sub>+1</sub> )	Email command code	
	Setting value	Status
	0x3370	Execute Email sending, when completed, value zero must be entered.
D3962 (CPU Written <sub>+1</sub> )	The message number of the Email to be sent	
D3963	Email send status	
	Content value	Status
	0	Standby
	1	Executing
	2	Send complete
	10	Email code error
	11	Send failed
	12	Construction data error
Network Parameters		
Register	Description	
D3978~D3981	Primary domain name server(DNS)IP	
D3982~D3985	Secondary domain name server (DNS)IP	
D3986	The first decimal number of the local network mask (MY_MASK.A)	
D3987	The second decimal number of the local network mask (MY_MASK.B)	
D3988	The third decimal number of the local network mask (MY_MASK.C)	
D3989	The fourth decimal number of the local network mask (MY_MASK.D)	
D3990 (CPU Written <sub>+1</sub> )	network parameter setting mode =0x4951, network parameters determined by register contents =0x4960, acquired using DHCP =other value, determined by the contents of the configuration tool	
D3991	The first decimal number of the board network address (MY_IP.A)	
D3992	The second decimal number of the board network address (MY_IP.B)	
D3993	The third decimal number of the board network address (MY_IP.C)	
D3994	The fourth decimal number of the board network address (MY_IP.D)	
D3995	The first decimal number of the router network address (ROUTER_IP.A)	
D3996	The 2'nd decimal number of the router network address (ROUTER_IP.B)	
D3997	The 3'rd decimal number of the router network address (ROUTER_IP.C)	
D3998	The 4'th decimal number of the router network address (ROUTER_IP.D)	
D3999	Board's serial number (S/N)	

Note 1: Example of network address (IP) 192.168.2.1, first code: 192, second code: 168, third code: 2, fourth code: 1.

Note 2: When D3990 is not 0x4951, after started up the contents of D3978~D3989 and D3991~D3998 will display the actual setting value.

Note 3: D3964~D3976 reserved.

## Chapter 3 CBEH Basic Configuration Settings

To set CBEH's basic configuration, the user can perform settings through the Ether\_Config software or the system webpage provided by CBEH. The comparison of the two setting methods are listed in the table below:

	Ether_Config software	CBEH system webpage
<b>Operation method</b>	<ul style="list-style-type: none"> <li>✧ Download v3.0 or above from FATEK's official website and install.</li> <li>✧ Can be connected to CBEH and perform settings through scanning the local area network or specify the exact IP address.</li> </ul>	<ul style="list-style-type: none"> <li>✧ Connect to the webpage by entering the IP address or device serial number in the web browser.</li> <li>✧ Use CBEH's built-in system webpage to perform configuration settings.</li> </ul>
<b>Suitable usage time</b>	<ul style="list-style-type: none"> <li>✧ When you don't know CBEH's IP address you can use the Ether_Config software to scan the local area network directly.</li> <li>✧ The user needs to use the Ether_Config software when perform the CBEH firmware updated.</li> </ul>	<ul style="list-style-type: none"> <li>✧ If CBEH's IP address setting matches the currently connected network sub-domain and the user knows this IP or board's serial number, users can login to the system webpage provided by CBEH through a web browser and perform configuration setting directly.</li> </ul>

Users can refer to the descriptions mentioned in the table above and chose the suitable method to set the device configuration according to their needs. The content of this chapter will describe configuration setting methods and the meaning of each setting fields.

### 3.1 Setting CBEH through the Ether\_Config software

Ether\_Config software V3.0 or above along with the FBs-CBEH module settings provide the following functions:

- Basic module data setting: Contents include network address, gateway address, network mask, operation mode, module identification name and module comment etc.
- Security setting: Authorized IP (network address) setting; when this function is used only command messages sent by authorized IP will be accepted by this module or expansion board.
- Local station number and remote network address and station number setting: The maximum number of slave station PLC that can be connected through the network is 254 stations; when the module operation is in client mode, in order

to map the local station number (to the main PLC) to the slave station PLC on the network, the mapping table must first be set when applying this function.

- Firmware update function: The Ether\_Config software provides the function to update the CBEH expansion board's firmware. Please refer to Chapter 10 for detailed operation contents.
- External service setting: CBEH provides internet clock synchronization (NTP Server), SMTP Server, Service Callback Server and DNS Server functions that require external services which can be set and used according to the user's needs.

Note	
	Only Ether_Cfg with version V3.0 or above supports the CBEH module.

The Ether\_cfg utility with version before V3.0 is not support CEBH, please first confirm the software version, or go directly to FATEK's official website to download the newest Ether\_Cfg software to configure CBEH. After opening the software, click on "About" in the main menu to display the following icon, you can find the version number behind Version:

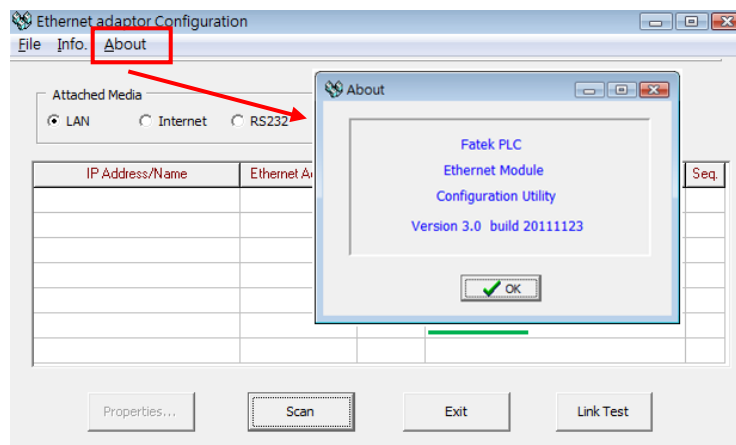

### 3.1.1 Connecting To CBEH Through LAN

When the CBEH and host computer (PC) is connected with local area network (LAN) and you do not know the CBEH expansion board's network address (IP), you can execute the Ether\_Config software and use the following method to connect to the CBEH expansion board:

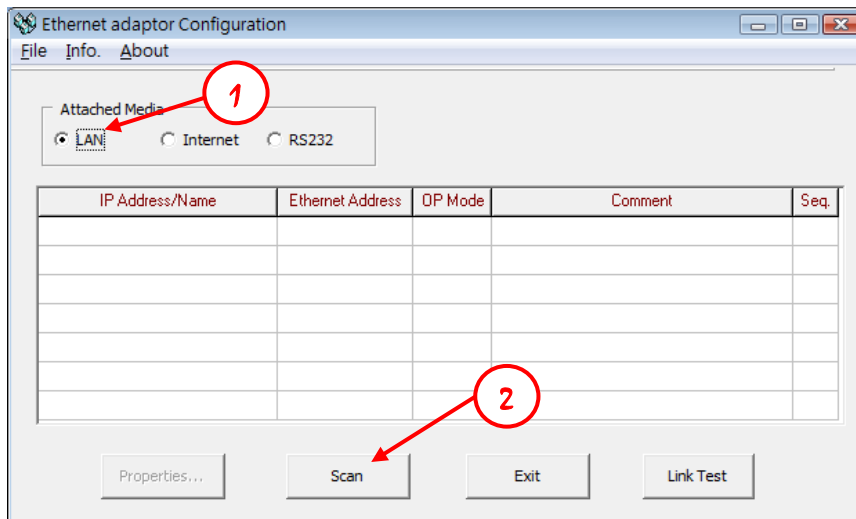

- ① Select LAN for Attached Media
- ② After clicking the Scan button it will start to scan the network modules online, all the detected modules will be display in the table in the middle of the window. When scanning is complete, move the mouse cursor over the module data row you want to set and left-click the mouse and select the Properties.. button, or just double click the mouse's left button to enter the module configuration window.

If you already know the CBEH expansion board's network address and the address matches the domain it is in, you can use the following method to connect the CBEH expansion board:

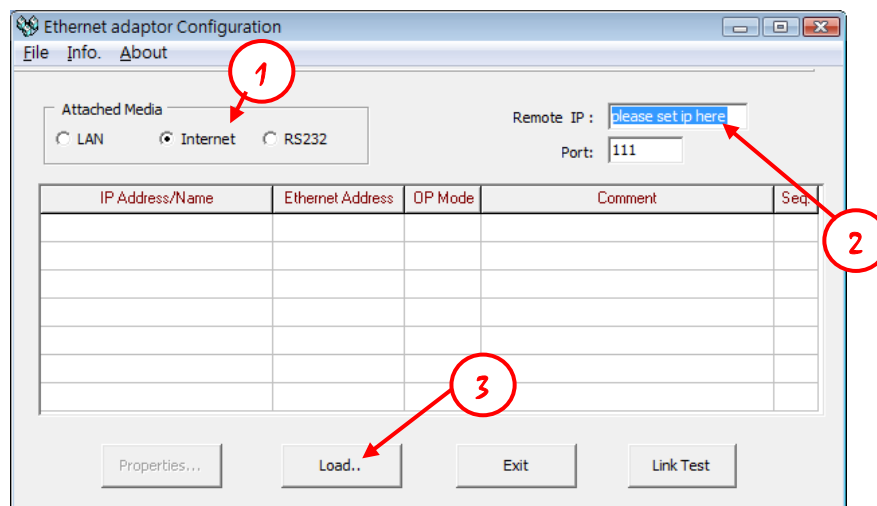

- ① Select Internet for Attached Media.
- ② Enter the CBEH expansion board's network address and communication port (default value is 111).
- ③ After clicking the Load.. button, it will start to connect to the network module with that network address; after receiving a response message, the data of that module will be displayed in the table in the middle of the window. At this time, move the mouse cursor over that module data row and left-click the mouse and select the Properties.. button, or just double click the mouse's left button to enter the module configuration window.

Note	
	<p>1. If you want to use this method to connect a PC and the CBEH in different domains, then that CBEH's Remote Config. Enabled option (please refer to the explanations in 3.1.2) must first be checked.</p> <p>2. When the CBEH module is behind a firewall, you must first open the firewall's port 111 to perform remote configuration setting.</p>

### 3.1.2 IP Address Setting

The first step to enter configuration setting is to set the CBEH expansion board's network, mask and gateway address, which is set on the General function tab as shown in the figure below:

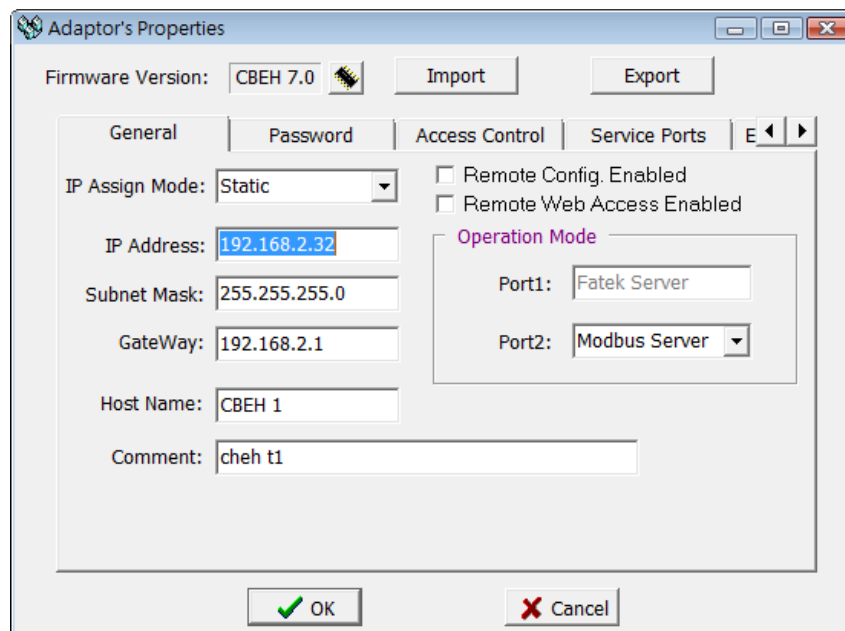

The following describes the meaning of each field for the user's reference:

- **IP Assign Mode:** IP acquisition mode. Users can set according to their application needs, there are:
  1. Static: Static acquisition. User needs to manually set the network, mask and gateway address.
  2. DHCP: Dynamic acquisition. User does not need to set the network, mask and gateway address; usable address will be acquired through the DHCP server's status.
  3. By PLC: The CBEH module acquires the network address from the PLC's register (Please refer to the descriptions in Chapter 2).
- **IP Address:** The network address of this expansion board.
- **Subnet Mask:** The subnet mask of this expansion board.
- **GateWay:** The external gateway of the domain where this expansion board is located.
- **Host Name:** Used for commenting, able to identify different modules; a

- maximum of 11 characters can be entered.
- **Comment:** Used for commenting; used to explain detailed module information, a maximum of 21 characters can be entered.
  - **Remote Config. Enable:** Used for security setting. When checked, it allows remote setting of Ether\_Config through the internet. This item must be checked if you want to use the internet setting method mentioned above; it is suggested to use a password along with this method in order to avoid security leakages. Please do not check this option if not necessary in order to avoid inappropriate changes.
  - **Remote Web Access Enable:** Used for security setting. When checked, it allows remote web page operations through the internet. This item must be checked if you want to use the internet setting method mentioned above; it is suggested to use a password along with this method in order to avoid security leakages. Please do not check this option if not necessary in order to avoid inappropriate changes.
  - **Import, Export:** Use the Export function to save all of the module's setting information, and later on use the Import function to read the Exported file or file generated with offline editing (please refer to the descriptions in 3.1.8) for more convenient module data setting.

### 3.1.3 Operation Mode Setting

Under the **General** setting page, in addition to setting fields related to the IP address, there's also a section used to set the operation mode, as shown in the figure below:

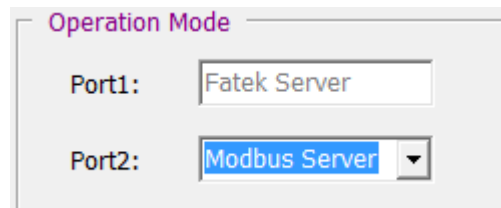

The screenshot shows a configuration window titled "Operation Mode". It contains two rows of settings. The first row is labeled "Port1:" and has a text input field containing "Fatek Server". The second row is labeled "Port2:" and has a dropdown menu with "Modbus Server" selected and a downward arrow on the right.

Port1 is fixed to be used for the FATEK Server can be used for the editing of ladder programs or the accessing of data. Port2 is used to support Modbus/TCP or FATEK client mode. When Port2 is selected to Modbus client mode or Fatek client mode, the user must also set the "Properties" setting in the Port Mapping setting page (please refer to the descriptions in chapter 3.1.4).

### 3.1.4 Access Control

Access Control Setting: Set authorized IP to restrict inappropriate data accessing. To set authorized IP, you can click the Access Control setting page and the following screen will appear:



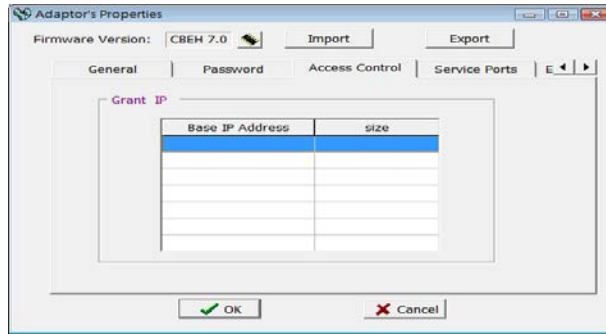

While setting, you can move the mouse cursor into the table and right-click the mouse, a menu will pop out as shown below:

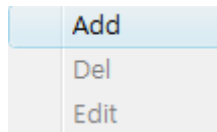

Click **Add** to add a new authorization data entry. Click **Del** to delete an authorization data entry. Click **Edit** to modify an authorization entry. The following screen will appear after clicking **Add**:

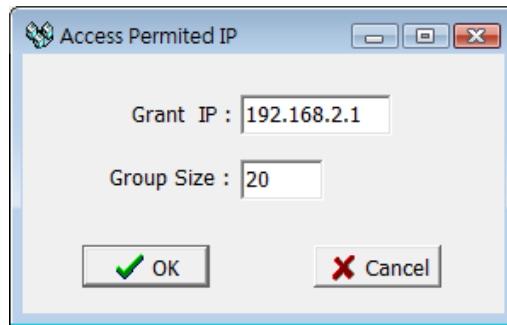

Use this screen to set a group of consecutive authorized IP (or PLC station number). Please enter the smallest IP address in the Grant IP field, and in the Group Size field, enter the number of corresponding controllers.

### 3.1.5 Port Mapping

When the operation mode of Port2 is set as Modbus/Fatek client mode in the basic settings page, an extra port mapping tab will appear. The following screen will appear after clicking the tab with the mouse:

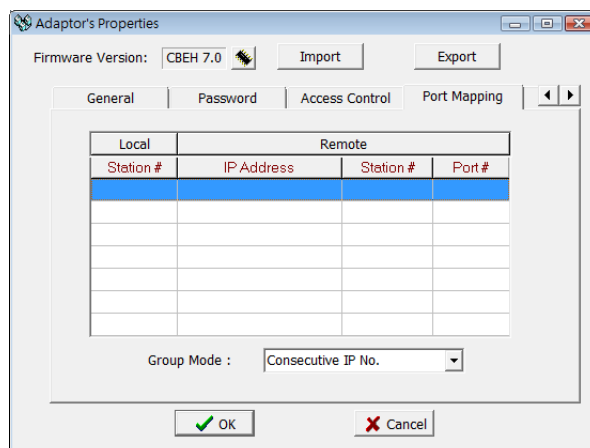

There is a “Group Mode” combo list providing the “Group Mode” selection, its meaning is as follows:

- **Consecutive Station No.:** Consecutive station number. When the Group Size is specified, its contents will be set to a fixed network address and continuous station numbers, as shown in the figure below:

Station #	IP Address	Station #	Port #
1~3	192.168.2.1	1~3	500

- **Consecutive IP No.:** Consecutive network address. When the Group Size is specified, its contents will be set to consecutive network addresses and a fixed station number, as shown in the figure below:

Station #	IP Address	Station #	Port #
1~3	192.168.2.1~3	1	500

Note: Group mode setting will apply to entire table; data can not be set entry by entry.

When setting is needed, you can move the mouse cursor into the table and right-click the mouse, a menu will appear as shown below:

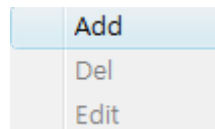

Click **Add** to add a new mapping data entry. Click **Del** to delete a mapping data entry. Click **Edit** to modify a mapping data entry. The following screen will appear after clicking Add:

The following is the meaning of each field:

- **Local Station:** Represents the remote PLC’s station number at the local end.
- **Remote Station:** Represents the station number of the mapped remote PLC.
- **Remote IP:** The IP address of the remote PLC.
- **Remote Port:** The IP port number of the remote PLC.
- **Group Size:** When Group mode is set to **Consecutive Station No.**, a mapped group station numbers can be defined one at a time; for example, if you want to set the local station numbers 10~19 to map the remote station numbers 20~29, and the remote IP is 192.168.1.3, you can set Local Station=10, Remote Station=20, Group Size=10, Remote IP=192.168.1.3, the Remote Port is generally set to 500. A maximum of 18 group mapping can be set within the Ethernet interface conversion module. When Group mode is set to **Consecutive IP No.**, a group IP mapping can be defined at once for this setting.

### 3.1.6 Service Ports

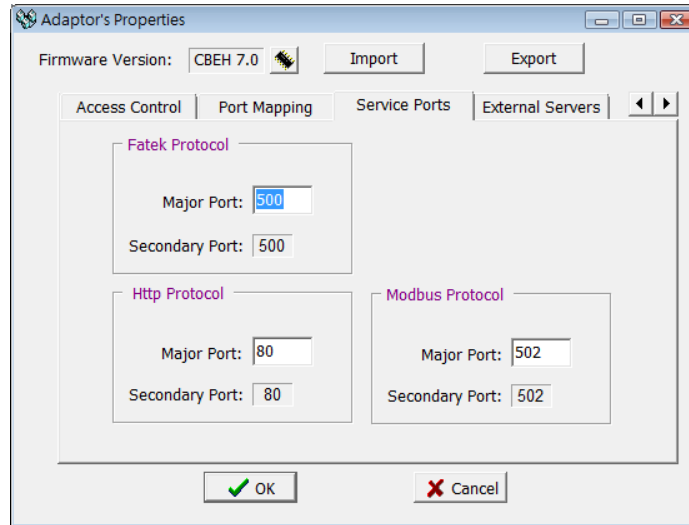

When the CBEH expansion board is working under TCP or UDP server mode, the external service ports must be set so that the external client workstations can send service requests according to the set service port numbers.

CBEH's default FATEK communication protocol service port is 500, Modbus' communication protocol service port is 502, Http communication protocol service port is 80. A maximum of 2 service port numbers can be provided to each service at the same time; one is a fixed default port (Secondary Port) and the other is a modifiable port (Major Port). If the user wants to modify the latter to a non-default port number, the Service Ports setting page can be used to make the modification. While modifying, just enter the port number you want to modify to in the Major Port field.

### 3.1.7 Password

Password protection: The factory's default password is 1234; if the user wants to change the password, they can click the Password setting page and the following screen will appear:

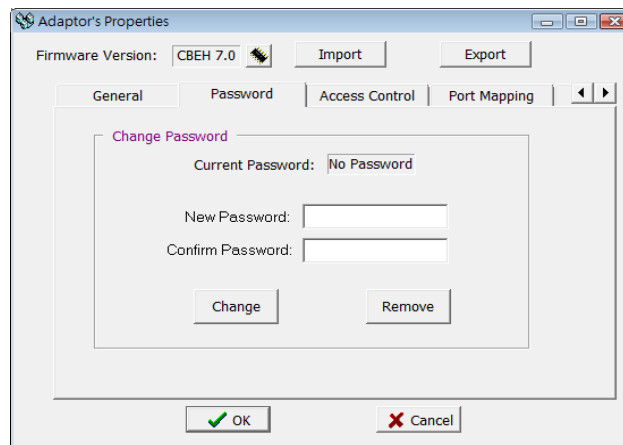

Just enter the password you want to use in the New Password and Confirm Password fields, and then press the Change button to complete the setting. To cancel the password, just press the Remote button.

### 3.1.8 External Servers

The CBEH expansion board provides some functions that require external services; to use these functions, click the External Servers setting page, and the following screen will appear:

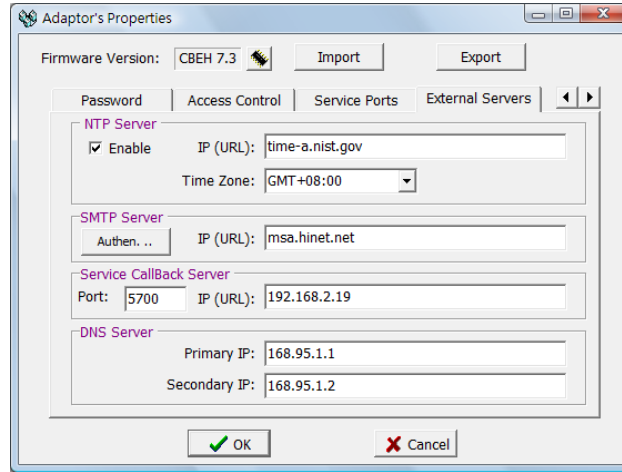

**NTP Server:** The CBEH expansion board provides the internet clock synchronization function, eliminating the trouble of manually correcting the time on a regular basis. To activate this service, just check Enable; when the service is activated, it will periodically request the newest clock data from the NTP server and set the data into Calendar register (D3953~D3960) accordingly (Please refer to Chapter 6 for details).

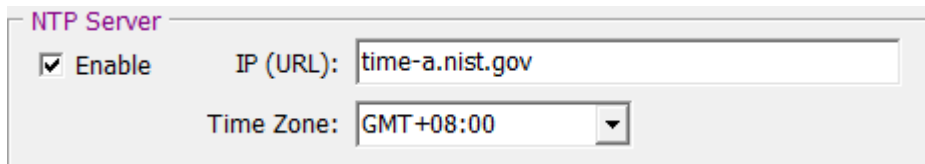

- **IP(URL):** The IP address of the internet time server (NTP server), please refer to the setting of the PC for internet time server address and directly paste it over to use.
- **Time Zone:** The time zone of the application location; the example above uses Taipei GMT + 08:00, which means that the time zone of Taipei is Greenwich Standard Time + 8 hours.

**SMTP Server:** The CBEH expansion board provides Email sending function; to use this function, the working address of the messenger server must be filled into the IP(URL) field.

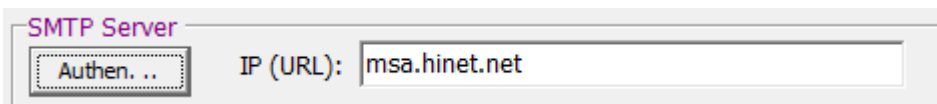

✧ **IP (URL):** Outgoing Email server address.

Attention: Generally, SMTP Server does not need security check. When you realized SMTP Server needs security check, please chooses **Authen. ..** and then the following message will be shown. Fill in your login name and password of SMTP

## Server

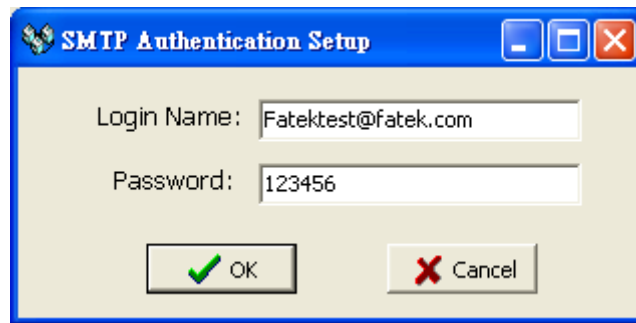

- ✧ **Login Name** : SMTP Server Account ◦ (including Domain Name)
- ✧ **Password** : SMTP Server Password ◦

**Service Call Back Server:** The CBEH expansion board provides the automatic service callback function; to use this function, the user must first fill in the network address and port number of the working callback server.

Service CallBack Server	
Port:	5700
IP (URL):	192.168.2.19

- ✧ **Port:** Service center's IP port number.
- ✧ **IP (URL):** Service center's IP address or domain name.

**DNS Server:** Domain Name Server. When the CBEH's external server IP address is filled in with the domain name format, it will require the use of external domain name query services. To use this service, the user must first fill in the data of the following fields; you can refer to the Windows operating system's primary DNS and secondary DNS fields in the internet option settings to perform this setting. If the IP acquisition mode is set to dynamic (DHCP) mode, then setting is not needed. The DNS setting in the figure below is the DNS server location of Chunghwa Telecommunications:

DNS Server	
Primary IP:	168.95.1.1
Secondary IP:	168.95.1.2

- Primary IP: Main DNS Server.
- Secondary IP: Backup DNS Server.

### 3.1.9 Offline Configuration Setting

In addition to connecting to CBEH and directly editing its configuration settings, the Ether\_cfg software also provides an offline mode configuration editing function. By using this function, the user can first perform the CBEH configuration content editing task under a no internet environment, and save the edited content into a file, and later on when connected, use the Import function to access the configuration

contents saved on the file and directly perform settings to CBEH.  
The following are the operation steps and description:

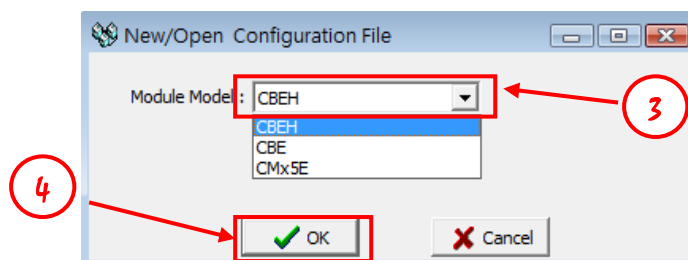
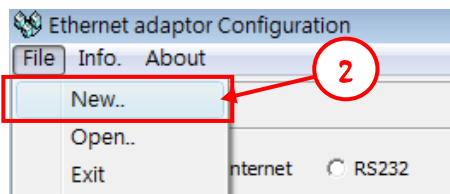
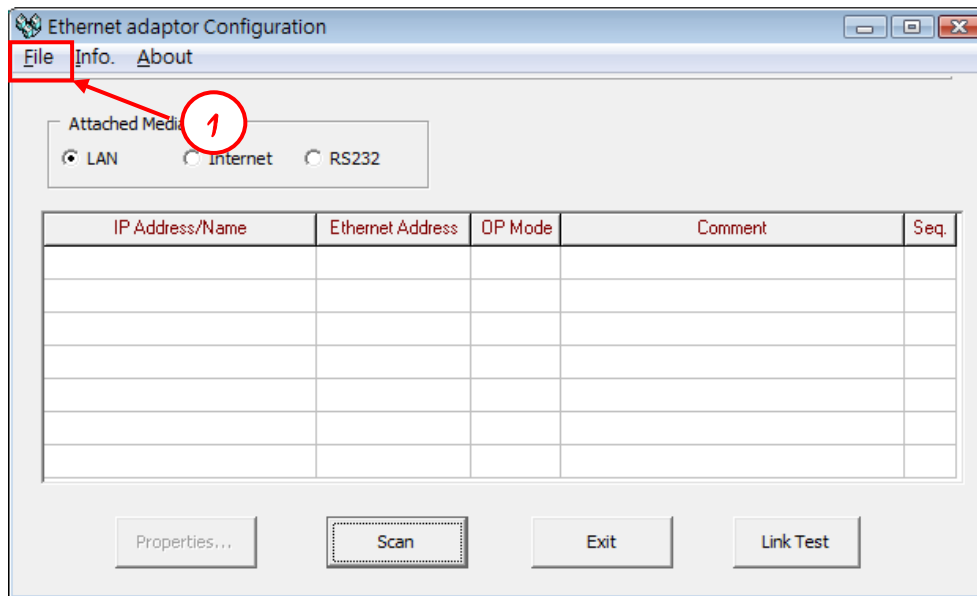

- ① Open the Ether\_Cfg software and select File from the main menu above.
- ② Select **New...** from the menu to start creating the offline configuration setting file.
- ③ Select CBEH for the Module Model.
- ④ Click the **OK** button to start the setting and editing of offline configuration.  
The configuration editing method is the same as the previous chapters (please refer to Chapters 3.1.2 to 3.1.8).

When configuration editing is complete, you can follow the following steps to save the setting file:

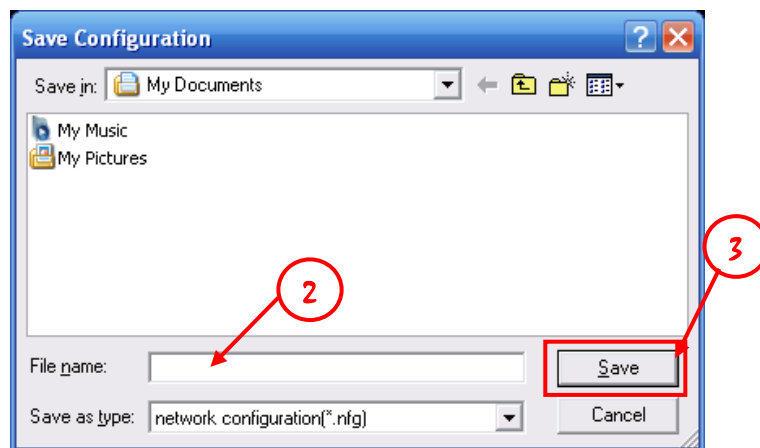
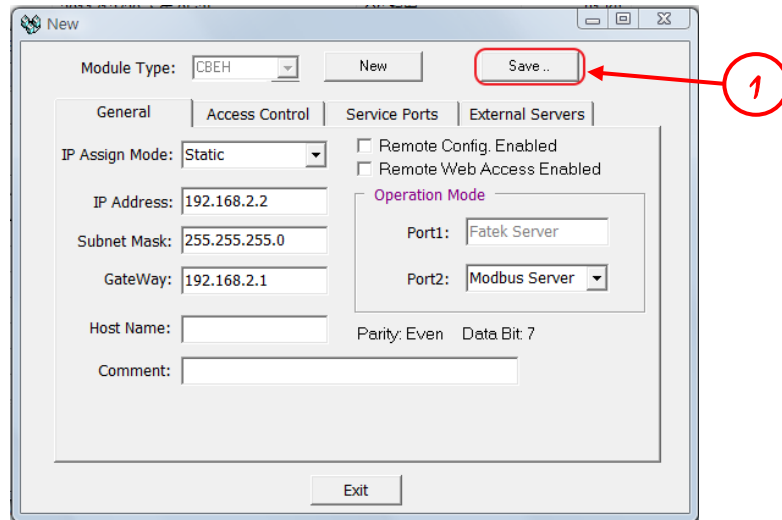

- ① Click the **Save..** button
- ② Select the location to save the file and enter the file name in the File Name field.  
Note: The file's extension is \*.nfg
- ③ Click the **Save** button to complete the saving. When the user uses the Import function, this file will be used; after it is read, the previously saved configuration setting will be imported into the module. (Please refer to the descriptions in Chapter 3.1.1 for the Import/Export functions).

### 3.2 Setting CBEH Through Web Browsers

When the user already knows the CBEH expansion board's network address, and that address matches the actual connecting domain section (for example if the actual domain section is 192.168.2.X and the expansion board's network address is 192.168.2.5), then web browsers can be used to enter the webpage provided by the expansion board to perform configuration settings (of course the PC must also be able to connect to that domain section). Open the web browser and enter CBEH's network address in the web address column to get the login web page. As shown in the example below, when the IP address of the CBEH to be connected is 192.168.2.32, then in the web browser, enter:

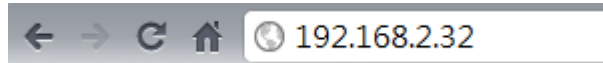

If the IP is correct then the login page will be shown as follow

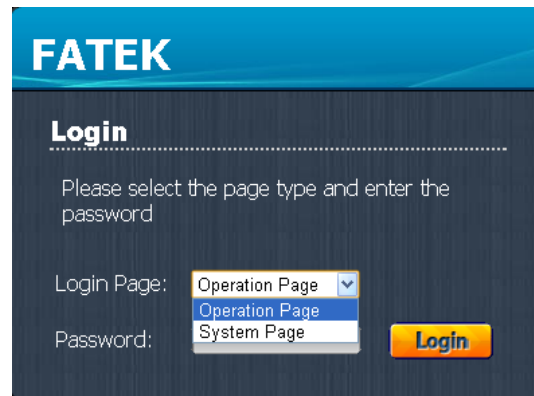

On the login page, users must select the system page from the “login page” combo list and enter the password (**the default factory setting of password is 1234**), then press the **Login** button to log in. If the password is correct, it will enter the system page.

### 3.2.1 System Page

The system page provides related setting and control for CBEH’s basic configuration, external services, and real-time monitoring etc. for the user; the user can understand the entire system page’s environment and architecture from the figure below.

- The operation sequence of the system page is:
  - I. Select the item to set from the function menu.
  - II. Complete the setting to modify in the function setting page.
  - III. Click the **Apply** button to apply the settings.
  - IV. Click the **Update Settings To PLC** button to update the applied settings onto the CBEH expansion board.



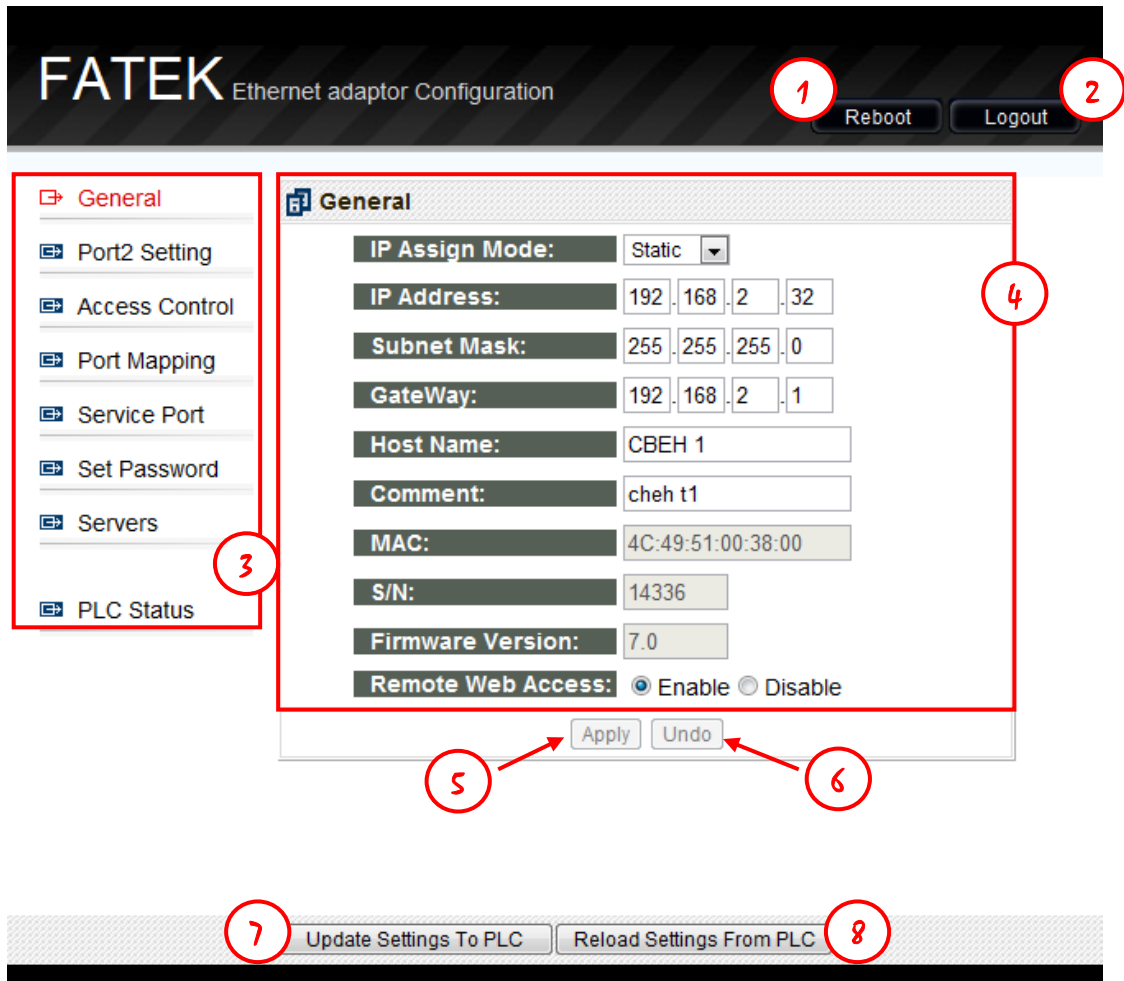

- ① **Reboot** Reboots the system
- ② **Logout** Logs out of the system page
- ③ **Function menu**
- ④ **Function setting page**
- ⑤ **Apply** applies the currently modified contents to this page, but this modification is not yet updated to the CBEH expansion board
- ⑥ **Undo** Restore the most recently applied settings
- ⑦ **Update Settings To PLC** Updates all of the modified content onto the CBEH expansion board
- ⑧ **Reload Settings From PLC** Discard the edited content and read the CBEH expansion board's setting again

### 3.2.2IP Address Setting

Common data setting: Set the module's network address, mask and gateway parameters. To set these parameters click the General setting page, and the following screen will appear:

General	
IP Assign Mode:	Static
IP Address:	192 . 168 . 2 . 32
Subnet Mask:	255 . 255 . 255 . 0
GateWay:	192 . 168 . 2 . 1
Host Name:	CBEH 1
Comment:	ch eh t1
MAC:	4C:49:51:00:38:00
S/N:	14336
Firmware Version:	7.0
Remote Web Access:	<input checked="" type="radio"/> Enable <input type="radio"/> Disable
<input type="button" value="Apply"/> <input type="button" value="Undo"/>	

The following describes the meaning of each field:

- **IP Assign Mode:** IP acquisition mode. Users can set according to their application needs, there are:
  1. Static: Static acquisition. User needs to manually set the network, mask and gateway address .
  2. DHCP: Dynamic acquisition. User does not need to set the network, mask and gateway address; usable address will be acquired from the DHCP server.
  3. By PLC: The CBEH module acquires the network address from the PLC's register (Please refer to the descriptions in Chapter 2).
- **IP Address:** The network address of this expansion board.
- **Subnet Mask:** The subnet mask of this expansion board.
- **GateWay:** The external gateway of the domain where this expansion board is located.
- **Host Name:** Used for commenting, able to indentify different modules; a maximum of 11 characters can be entered.
- **Comment:** Used for commenting; used to explain detailed module information, a maximum of 21 characters can be entered.
- **MAC:** The MAC Address of this expansion board.
- **S/N:** The manufacturing serial number of this expansion board. The CBEH expansion board can use this serial number to directly connect to the web page. Using serial number 14336 in the figure above as a usage example, in the browser web address column enter: <http://fac14336> to connect to the web page. This method can only be used under the local area network (LAN) connection.
- **Firmware Version:** Displays the expansion board's firmware version.
- **Remote Web Access:** Security setting. When checked, it allows remote web page setting through the internet. This item must be checked if you want to use the internet setting method mentioned above.

Note	
	<p>It is suggested to use the password protection when <b>Remote Web Access</b> is checked in order to avoid security leakages. Please do not check this option if not necessary in order to avoid malicious access.</p>

### 3.2.3 Operation Mode Setting (Port2 Setting)

Port1 is fixed and used for the FATEK Server, Port2 is used to support Modbus/TCP or FATEK client mode. To set Port2 mode, click on the Port2 setting page and you will see the following screen:

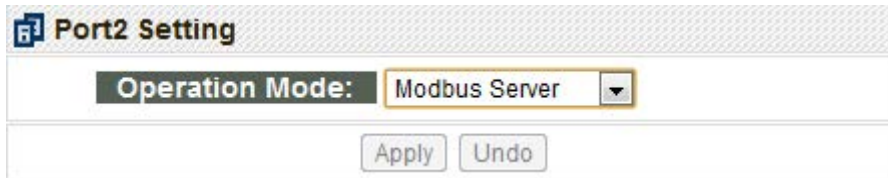

Click the combo list box behind Operation Mode to select one of the following operation modes:

1. FATEK Client
2. Modbus Server
3. Modbus Client

When Port2 is selected to Modbus client mode or Fatek client mode, the user must perform settings in the Port Mapping setting page (please refer to Chapter 3.2.4 for detailed descriptions). Select according to the user's need and then click the Apply button to complete the setting.

### 3.2.4 Access Control



Access control: Set authorized network address to restrict inappropriate data accessing. To set authorized network address you can click the Access Control setting page and the following screen will appear:

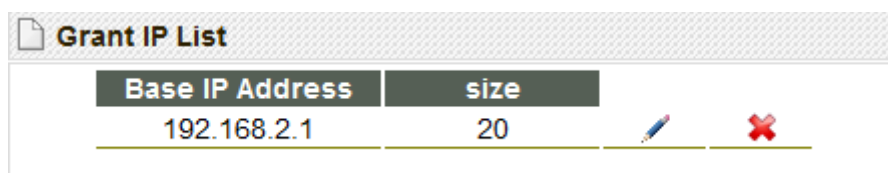

When setting is required you can fill in the authorization data in the New/Edit-Grant IP field; in the Grant IP field, enter the smallest IP address, and in the Group Size field, enter the number of IPs; click the Add button when completed. To modify or delete an authorization data, click the icons behind the Grant IP List field to perform the operations:



Base IP Address	size
192.168.2.1	20

The  icon is modify; when pressed, it will change to the  icon, and the highlighted parts will turn red, then you can modify above the field and then press Apply to complete the modification. To delete an authorization data, click the  icon directly to delete it.

### 3.2.5 Port Mapping

When the operation mode in the basic settings page is set as Modbus/Fatek client mode, an extra port mapping page will appear. The following screen will appear after clicking it with the mouse:

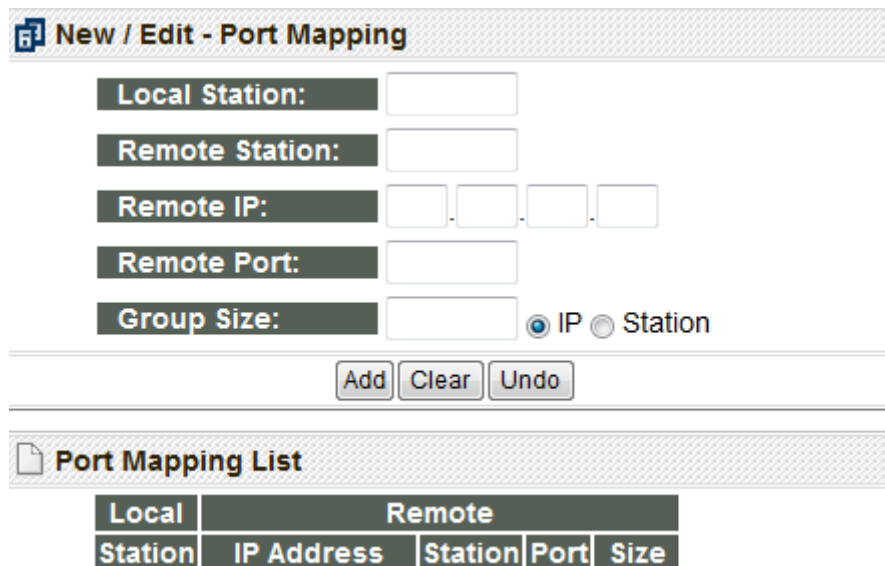



Local Station	Remote Station	Remote IP	Remote Port	Group Size	IP	Station
<input type="text"/>	<input type="text"/>	<input type="text"/> - <input type="text"/> - <input type="text"/> - <input type="text"/>	<input type="text"/>	<input type="text"/>	<input checked="" type="radio"/>	<input type="radio"/>



Local Station	Remote IP Address	Remote Station	Remote Port	Remote Size

When setting is required, users can enter the mapping data in the New/Edit-Port Mapping fields. The following is the meaning of each field:

- **Local Station:** Represents the remote PLC's designated station number at the local end.
- **Remote Station:** Represents the actual station number of the mapping network remote PLC.
- **Remote IP:** The IP address of the remote PLC.
- **Remote Port:** The IP port number of the remote PLC.
- **Group Size:** A group of station numbers mapping can be defined every time for this setting; for example, if you want to set the local station numbers 10~19 to map the remote station numbers 20~29, and the remote IP is 192.168.1.3, you can set Local Station=10, Remote Station=20, Group Size=10, Remote IP=192.168.1.3, the Remote Port is generally set to 500. A maximum of 18 group mapping can be set within the CBEH.
- **IP:** Consecutive network addresses. When the Group Size is specified, its contents will be a consecutive network address and a fixed station number configuration, as shown in the figure below:



Port Mapping List					
Local		Remote			
Station	IP Address	Station	Port	Size	
1	192.168.2.1~	1	1	3	 



- **Station:** Consecutive station number. When the Group Size is specified, its content will be a fixed network address and consecutive station number configuration, as shown in the figure below:

Port Mapping List					
Local		Remote			
Station	IP Address	Station	Port	Size	
1	192.168.2.1	1~	1	3	 

Note: The Group's IP or Station radio button setting is a global setting; it can not be set entry by entry.

To modify or delete a mapping data, you can press the icons behind the Port Mapping List field to operate:

Port Mapping List					
Local		Remote			
Station	IP Address	Station	Port	Size	
1	192.168.2.1	1	500	1	 

The  icon is an edit tool; when pressed, it will change to the  icon, and the highlighted parts will turn red, then you can modify above the field and then press Apply to complete the modification. To delete a data, click the  icon directly to delete the mapping data.

### 3.2.6 Service Port

The service ports must first be set before the server function of this expansion board can operate; the external client-ends will use this service port to send connection requests to the CBEH module and so the messages can be received by this expansion board.

CBEH's default FATEK communication protocol service port is 500, Modbus' communication protocol service port is 502, Http communication protocol service port is 80. A maximum of 2 service port numbers can be provided to each service at the same time, in which one is a fixed default port and the other is a modifiable port. If the user wants to modify the modifiable service port, the Service Ports setting page can be used to make the modification. While modifying, just enter the port number you want to modify into the Major Port field.

<b>Fatek Protocol</b>	
Major Port:	500
Secondary Port:	500
<b>Modbus Protocol</b>	
Major Port:	502
Secondary Port:	502
<b>Http Protocol</b>	
Major Port:	80
Secondary Port:	80
<input type="button" value="Apply"/> <input type="button" value="Undo"/>	

### 3.2.7 Password

Password protection: To set the password, click the Set Password setting page, and the following window will appear:

<input type="checkbox"/> <b>User - Set New Password</b>	
New Password:	.....
Confirm:	.....
<hr/>	
<input type="checkbox"/> <b>System - Set New Password</b>	
New Password:	.....
Confirm:	.....
<input type="button" value="Set"/>	

According to operation privilege differences, the CBEH module divides the password section into User password and System password. To enter an operation page, the user password or system password must be entered in order to log in; and to enter the system webpage, the system password must be entered to log in. There is no password set for the default factory user password, and the default factory system password is 1234.

If modification to the user or system webpage password is required, you can check the box in the page and enter the same password twice and then press the Set button to complete the modification:

<input checked="" type="checkbox"/> <b>System - Set New Password</b>	
New Password:	....
Confirm:	....
<input type="button" value="Set"/>	

Hint	
	If the password protection mechanism is not needed, check the corresponding page and press the Set button directly to cancel the password.

### 3.2.8 External Servers

The CBEH expansion board provides some functions that require external services; to use these functions, click the “External Servers” setting page, and the following screen will appear:

**External Servers**

**DNS Server 1:** 168 . 95 . 1 . 1

**DNS Server 2:** 168 . 95 . 1 . 2

**NTP IP(URL):**  time-a.nist.gov

**Time Zone:** GTM +8:00

**SVC IP(URL):** 192.168.2.19

**SVC Port:** 5700

**SMTP Server:** msa.hinet.net

Apply Undo

**DNS Server:** Domain name service server. Just like the primary DNS and secondary DNS set on the PC. This setting is not necessary if the network address setting is set to the dynamic (DHCP) mode. The preferred DNS setting in the figure below is the DNS server address of Chunghwa Telecommunications:

**DNS Server 1:** 168 . 95 . 1 . 1

**DNS Server 2:** 168 . 95 . 1 . 2

- **DNS Server 1:** IP address of primary DNS Server.
- **DNS Server 2:** IP address of secondary DNS Server.

**NTP Server:** The CBEH expansion board provides the internet clock synchronization function, eliminating the trouble of manually correcting the time on a regular basis. To enable this service, just check the box and enter the NTP server address; when the service is enabled, the synchronization time data can be queried from the NTP Calendar register (D3953~D3960) (Please refer to Chapter 6 for details).

**NTP IP(URL):**  time-a.nist.gov

**Time Zone:** GTM +8:00

- **NTP IP (URL):** The IP address or domain name of the NTP server. There are many NTP servers all over the world. The easiest way to get the IP address of NTP server is to refer the setting of PC.
- **Time Zone:** Time zone configuration; the example above uses Taipei GMT + 08:00, which means that the time zone of Taipei is Greenwich Standard Time + 8 hours.

**Service Call Back Server:** The CBEH expansion board provides the automatic service callback server function; to use this function, the user must first fill in the network

address and port number of the maintenance center:

<b>SVC IP(URL):</b>	<input type="text" value="192.168.2.19"/>
<b>SVC Port:</b>	<input type="text" value="5700"/>

- ✧ **SVC IP(URL):** Service center's network address or domain name address
- ✧ **SVC Port:** Service center port number.

**SMTP Server:** The CBEH expansion board provides Email sending function; to use this function, just enter the send server's IP address or domain name into the SMTP Server field:

<b>SMTP Server:</b>	<input type="text" value="msa.hinet.net"/>
---------------------	--------------------------------------------

- ✧ **SMTP Server:** Outgoing Email server IP address or domain name.



## Chapter 4 Customized Web Page Design

The FBs-CBEH expansion board provides the web server function, in addition to the system webpage, it also allows users to create own customized webpage to easily browse or control the status within the PLC. In order to help the user to create their own web page without knowing the web page authoring language - HTML, a convenient software – “Easy Web Designer” is provided. Below we will introduce how to complete a customized webpage by using this software.

### 4.1 Changing Web Page Style

The changing of webpage style is mainly to customize the login page for different languages (locale). The styles include displayed font style of the web page, the company name, web page title, description string of the login page and login error hint messages etc., this changes can be made by using the “Easy Web Designer” software.

#### Login page style

The webpage login page provided by the FBs-CBEH expansion board is as shown in the figure below; the indicators specified in the figure are parts where the style can be changed.

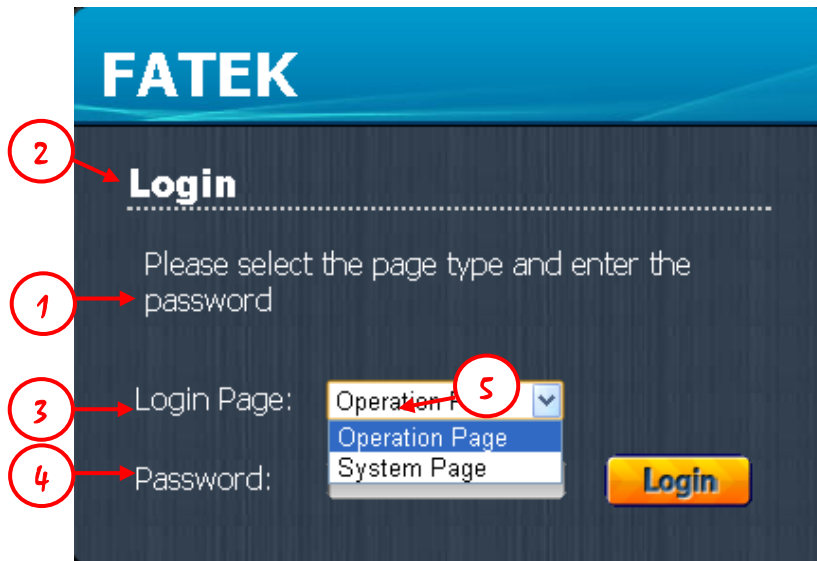

- ① Webpage title: The operation description text of the login screen.
- ② Company title: The title text displayed on top of the login screen.
- ③ Page selection title: The title text displayed on the login screen in front of the page selection item.
- ④ Password title: The title text displayed on the login screen in front of the password input box.
- ⑤ Operation page string: The selection string displayed on the login screen when the selected item is operation page.

System page string: The selection string displayed on the login screen when the selected item is system page.

If you want to change the setting described above, please follow the following steps to perform the setting:

Step 1, open Easy Web Designer, and double click on “Page Style Setting” on the created project.



Step 2, after double clicking, the style setting window will appear, click the “login page” tab to perform setting; detailed description of each field are as follows.

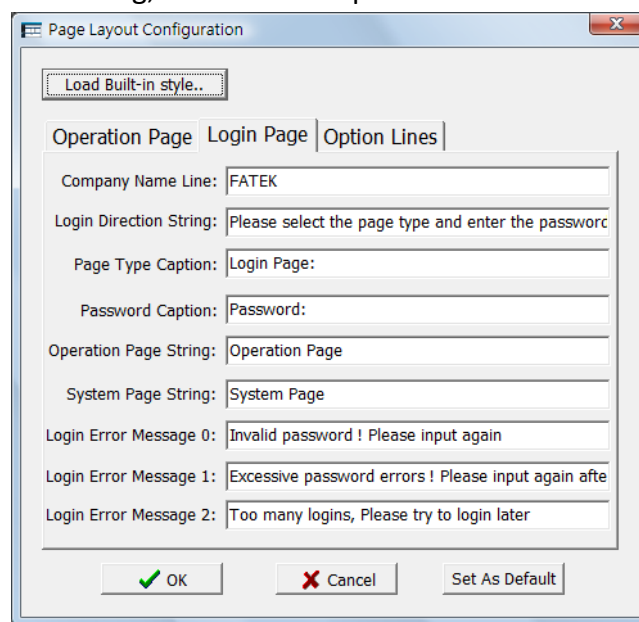

- Page title: The operation description text on the login screen.
- Company title: The title text displayed on top of the login screen.
- Page selection title: The title text displayed on the login screen before the page selection item.
- Password title: The title text displayed on the login screen in front of the password input box.
- Operating page string: The selection string displayed on the login screen when the selected item is operation page.
- System page string: The selection string displayed on the login screen when the selected item is system page.
- Login error message 0: The message displayed in the dialog box when there is a login error.
- Login error message 1: The message displayed in the dialog box when the wrong password has been entered 3 times.
- Login error message 2: The message displayed in the dialog box when the maximum allowed login count is exceeded when logging in.

## Operation-page style

The webpage operation-page provided by the FBs-CBEH expansion board is as shown in the figure below; the data specified in the figure are parts where the style can be changed.

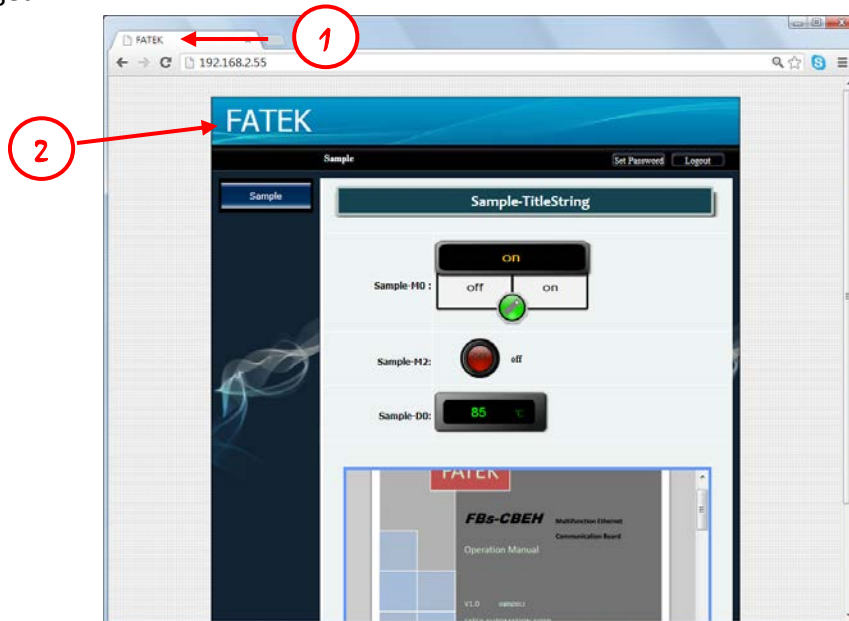

- ① Page title: The title text displayed on the web browser.
- ② Company title: The title text displayed on top of the login screen.

If you want to change the data described above, please follow the following steps to perform the setting:

Step 1, open Easy Web Designer, and double click on “Page Style Setting” on the created project.



Step 2, after double clicking, the style setting window will appear, click the “login page” tab to perform setting; detailed description of each field are as follows.

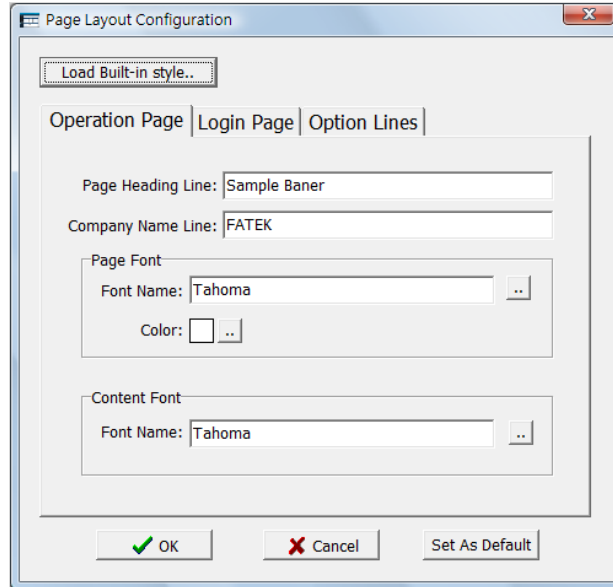

- Page title: The title text displayed on the web browser.
- Company title: The title text displayed on top of the login screen.

When operating, users can enter the string they want to set directly in the field mentioned above, or click the **Load Built-in style** button on top to apply it directly. The default style is selected from default styles provided for the three languages i.e. Traditional Chinese, Simplified Chinese and English.

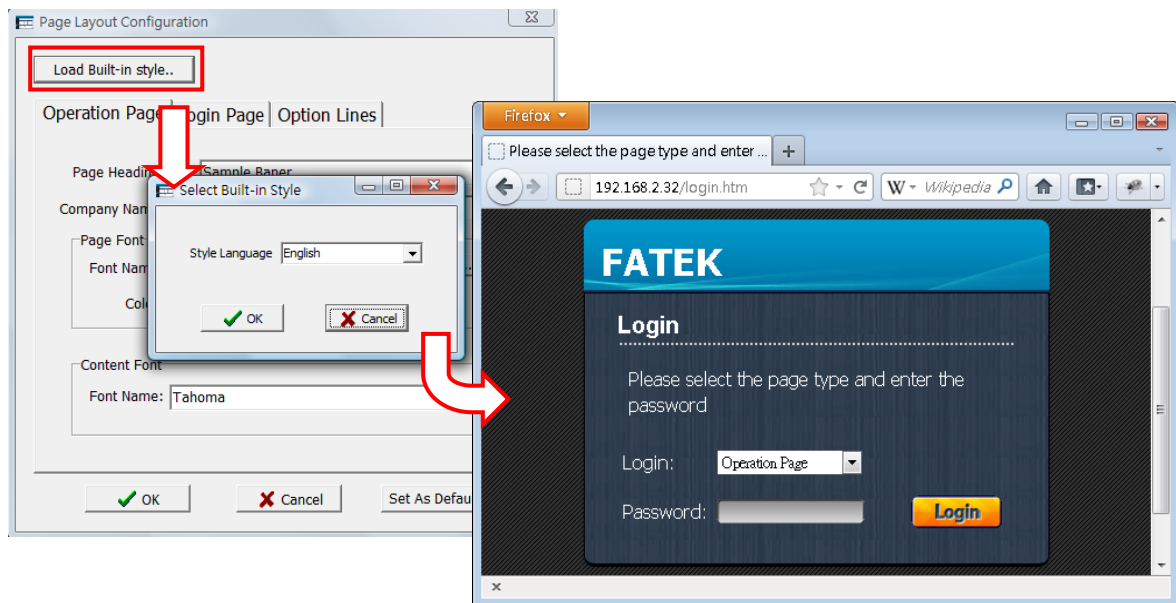



## 4.2 Adding Menus

The operation methodology of the customized webpage uses the Multi-level Menu navigation method. Through this method, complicated control operation and contents can be categorized into groups with a systematic and intuitive method to display and further achieving the goal of controlling. The figure below is an example of a user page. The webpage architecture composition includes the “Menu Item” to the left and the “Control Content” to the right, and every menu item is created by a hierarchical menu. A complete menu can have a maximum of two levels, and every level can contain a maximum of 10 menu items. The lowest level is formed by the content items. The method to creating a customized web page is as follows:

Step 1, add new menu item.

Open Easy Web Designer, and in the created project, click **Main Menu**, at this time a menu editing function button will appear on the toolbar.



- ✧ “  “ Add menu: Adding new menu items, a two-level button design is provided for the menu, the maximum menu item number for each level is 10.
- ✧ “  “ Export menu: Export the currently completed designing menu (\*.ewm).
- ✧ “  “ Import menu: Import the completed menu (\*.ewm).

In addition, you can also right-click on **Main Menu**, and similarly, the menu editing option will also appear.

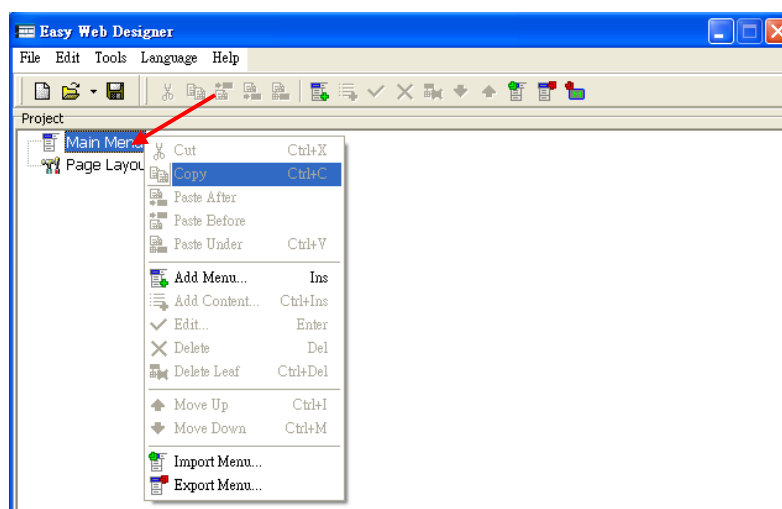

After clicking **Add new menu** with the two methods mentioned above, the following add new menu setting window will appear:

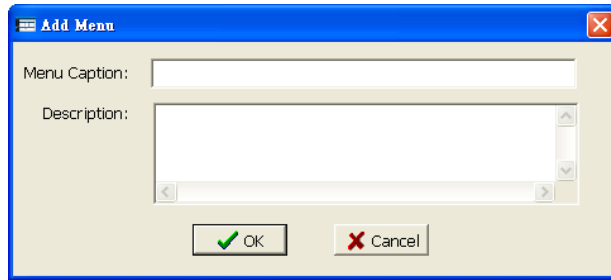

The **Menu Caption** in the add new menu setting window is the menu item text in the web page, and the **Description** part is only a comment in the Easy Web Designer. After filling out the Menu Caption content value, just press OK. As shown in the figure below, the first level menu item is added into the operation menu.

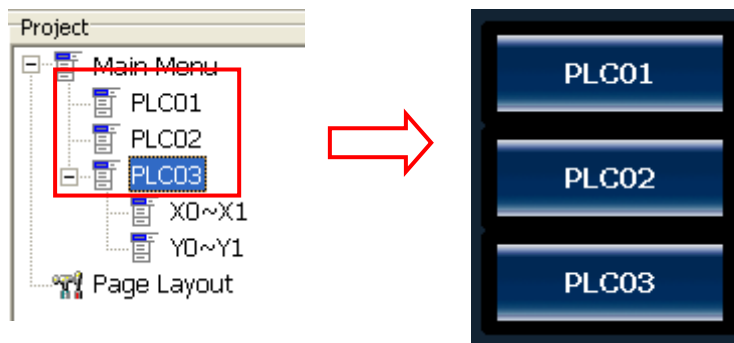

To add a second level sub-menu, just use the mouse and add a new menu in the first level menu just as described above, and as shown below, a sub-menu is added into the first level menu item.

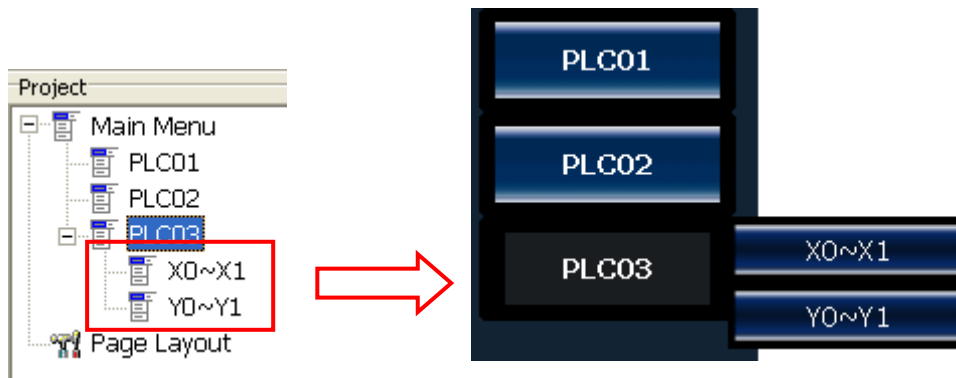

### 4.3 Add Contents

After completing the main menu items in Chapter 4.2, now you can start creating the control content page to display in every option; the figure below is an example of the control content design, the architecture composition of the control content uses a tabular format to list every control item, and every row represents a control content type.



The adding method of control contents is to click on the created menu; when the menu item is clicked, the “ Add Content” function button will appear on the toolbar. When this toolbar button is pressed the add new content function window will appear; select the content type needed to complete the setting and upload it onto the FBs-CPU module to achieve simple PLC controlling and status monitoring.

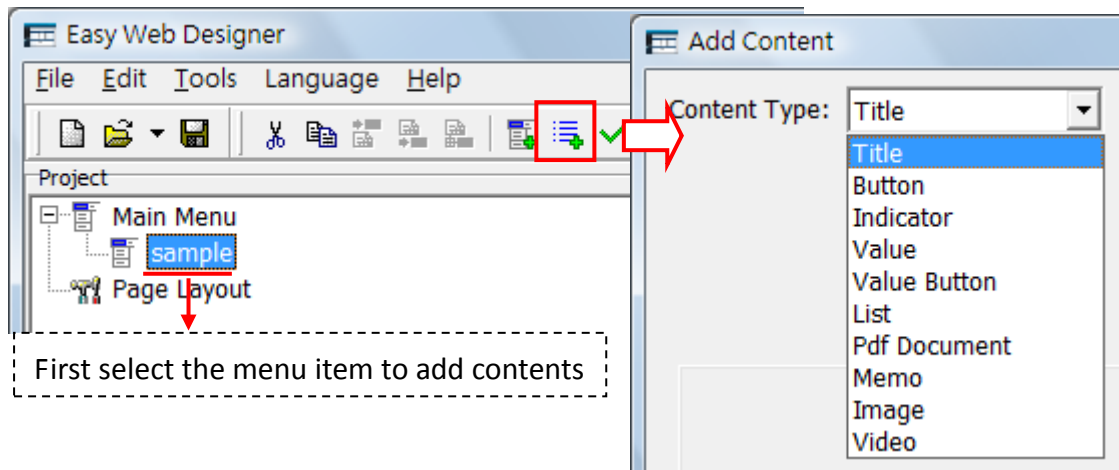

Easy Web Designer provides 10 types of content item, please refer to the table below for their setting methods:

➤ **Title**

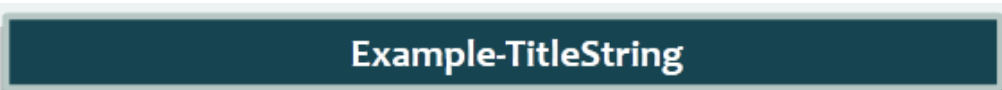
Function Description
Title text used for control item categorization; only used for identification, no actual control contents. When designing, title text can be used to separate control items with different features on the same page for easy identification.
Sample Screenshot

Setting Method	
Content Type: <input type="text" value="Title"/>	Title String: <input type="text" value="Example-TitleString"/>
	Description: <input type="text"/>

**Content Type:** Select "Title".

**Title String:** Fill in the title text to display.

➤ **Button**

Function Description	
Used to display and control the on/off state of a contact point.	
Sample Screenshot	
Example-Button M0 Switch :	
Setting Method	
Content Type: <input type="text" value="Button"/>	Title String: <input type="text" value="Example-Button M0 Switch"/>
Reference No.: <input type="text" value="M0"/>	Description: <input type="text"/>
Button Type: <input type="text" value="Toggle"/>	Status Color: <input type="text" value="Green"/>
Button Caption On State: <input type="text" value="Start"/> Off State: <input type="text" value="Stop"/>	
State Caption On State: <input type="text" value="ON"/> Off State: <input type="text" value="OFF"/>	

**Content Type:** Select "Button".

**Title String:** The title description of this button, such as the text displayed in the Sample Screenshot "Example-Button M0 Switch".



**Reference No.:** The reference number of contact point to be monitoring. The allowable reference are X, Y, M, S type.

**Button Type:** There are following buttons can be selected







“Toggle” – Change state for each button press.

“Set On” – Change to on when button press.

“Set Off” – Change to off when button press.

“Momentary On” - Change to on whenever the button is depressed, change to off when button is released.

“Momentary Off” - Change to on whenever the button is depressed, change to off when button is released.

Toggle	
Set On	
Set Off	
Set On/Off	
Momentary On	
Momentary Off	

**Status Color:**

There are green, red, blue and amber four colors can be selected for the base color of status bar(Momentary type)or button face (Toggle type) while using the high(state is 1) or low(state is 0) intensity to reflect the corresponding state.

**Button Caption :**

The following fields will be shown when the **toggle button** is selected.

On State- The entering text in this field will be shown on the button when the

state of corresponding variable is on.

Off State- The entering text in this field will be shown on the button when the state of corresponding variable is off.

The following fields will be shown when the **Set On/Off button** is selected.

Set On : The entering text in this field will be shown on the set on function button.

Set Off : The entering text in this field will be shown on the set off function button.



For the reset of buttons not mention above, there is only one text field need to enter which will be shown on the button.

**Status Caption:**

“On State” the text shown on the value field when the contact point is on state.

“Off State” - the text shown on the value field when the contact point is off state.

➤ **Indicator**

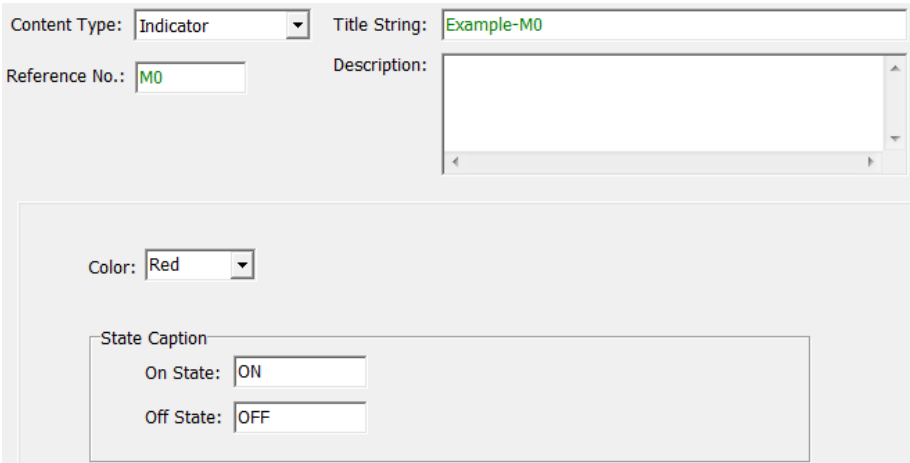
Function Description	
Monitor the status of variable by an animation lamp.	
Sample Screenshot	
Example-M0:	 ON
Example-M0:	 OFF
Setting Method	
	
<b>Content Type:</b> Select “Indicator”.	
<b>Title String:</b> The title description of this button, such as the text displayed in the	

Sample Screenshot “Example-Button M0 Switch”.

**Reference No.:** The reference number of contact point to be monitoring. The allowable reference are X, Y, M, S type.

**Color:**

There are green, red, blue and amber four colors can be selected for the base color of the lamp while using the high(state is 1) or low(state is 0) intensity to reflect the corresponding state.

**Status Caption:**

“On State” the text shown on the value field when the contact point is on state.  
“Off State” - the text shown on the value field when the contact point is off state.

➤ **Value**

**Function Description**

Used to display and control the contents of the register.

**Sample Screenshot**

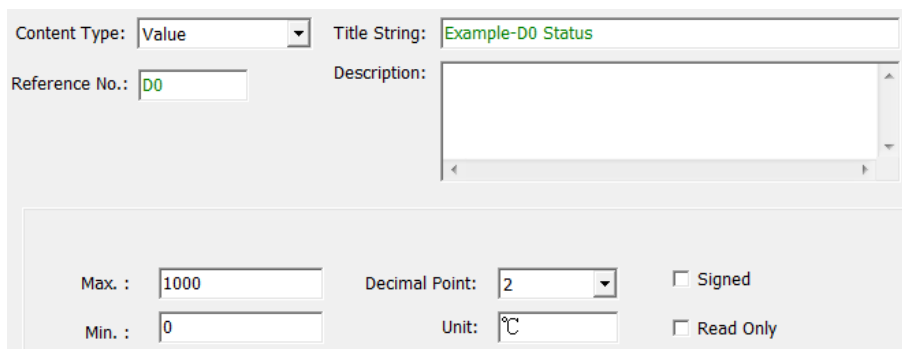

**Setting Method**

A screenshot of a configuration window for a "Value" item. It contains several fields: "Content Type" is a dropdown menu set to "Value"; "Title String" is a text box containing "Example-D0 Status"; "Reference No." is a text box containing "D0"; "Description" is a large empty text area; "Max." is a text box containing "1000"; "Min." is a text box containing "0"; "Decimal Point" is a dropdown menu set to "2"; "Unit" is a text box containing "°C"; and there are two checkboxes, "Signed" and "Read Only", both of which are unchecked.

**Content Type:** Select “Value”.

**Title String:** The title description of this Value item, such as the text displayed in the Sample Screenshot “Example-D0 Status”.

**Reference No.:** The reference number of the register to be controlled. The allowable reference are R, D, DR, DD type.

**Read Only:** If this option is not checked, it means that this value item can be altered and the keyboard icon “” will appear, the register’s data content can be modified. If checked, the keyboard icon will not appear and this value item only has the display function; the data content can not be changed.

**Max.:** When the control item is in a writable status, this sets the upper limit for the value that could be entered.

**Min.:** When the control item is in a writable status, this sets the lower limit for the value that could be entered.

**Decimal Point:** Add a decimal point symbol to the value displayed on the display value; this only displays on the application, it does not have any effect on register content.

**Unit:** The text is displayed behind the value; normally used to denote the value unit. This only displays on the application, it does not have any effect on controlled register.

**Signed:** If this box is checked, the value of the register will be interpreted as a number with sign.

The color of the display value will be changed to red color whenever the value is not within the range bounded by max. and min. value.

	Within the range	Out of range
Text Color	Green	Red
Sample display		

➤ **Value Button**

Function Description	
Used to display and control the contents of a register; it uses two buttons to modified the value of register. For each press of button, the register’s value will be increased or decreased by an amount.	
Sample Screenshot	
Example-Value Button R0:	
Setting Method	

Content Type: Value Button Title String: Example-Value Button R0

Reference No.: R0 Description:

Button Type: +/-

+Button Caption: 3 Max.: 1000

-Button Caption: -3 Min.: 0

Step/Set Value: 6  Signed

Decimal Point: 3 Unit: °C

**Content Type:** Select “Value Button”.

**Title String:** The title description of this control item, such as the text displayed in the Sample Screenshot “Example-Value Button R0”.





**Reference No.:** The number of the actual register to be controlled. The allowable reference are R, D, DR, DD type.

**Button Type:** There are following types can be selected

- “Set”- when the button is pressed, the data on the register is set to a fixed value;
- “+” when the button is pressed, a fixed value will be added to the data on the register;
- “-” when the button is pressed, a fixed value will be subtracted from the data on the register;
- “+/-” when a certain button is pressed, a fixed value will be added or subtracted from the data on the register.

**+Button Caption:** The text that will be shown on the set button. If the optional SVG parameter is set to 0(Please refer section 4.5 for explanation), the + and +/-(+ function) button will also display this text on it.

Sample display:

set		-	
+		+ /	

**-Button Caption:** If the optional SVG parameter is set to 0(Please refer section 4.5 for explanation) the – and +/- (- function) button will also display this text on it.

**Step/Set Value:** The fixed value, set value, add value, subtract value, add subtract value all use this value as their setting.

**Max.:** Set this value to restrict the maximum value can be set to the register.

**Min.:** Set this value to restrict the minimum value can be set to the register.

**Decimal Point:** Adds a decimal point symbol to the value displayed; this only displays on the application, it does not have any effect on controlled register.

**Unit:** The text is displayed behind the value; normally used to denote the value unit. This only displays on the application, it does not have any effect on controlled register.

**Signed:** If this box is checked, the value of the register will be interpreted as a number with sign.

The color of the display value will be changed to red color whenever the value is not within the range bounded by max. and min. value.

	Within the range	Out of range
Text Color	Green	Red
Sample display		

➤ **List**

Function Description	
Uses the list item to display and control the value of the register/contact with listed strings.	
Sample Screenshot	
Example-List D3:	
Setting Method	

Content Type: List    Title String: Example-List D3

Reference No.: D3    Description:

Count: 2     Read Only

List String:

Seq	Value	String
0	10	value_10
1	986	value_986

**Content Type:** Select "List".

**Usable Reference Number Type:** R, D.

**Title Text:** The title description of this list item, such as the text displayed in the Sample Screenshot "Example-List D3" .

**Reference No:** The reference number of the register/contact to be controlled.

**Count:** Total number of listed strings.

**List String:**

"Seq" List item number.

"Value": The value of register to be mapped.

"String": The string that mapped to the value in value field.

**Read Only:** If this item is checked, this control item only has the display function; the data content can not be changed.

➤ **PDF Document**

**Function Description**

With this content can embed the PDF document directly into the web page. While in application, machine builder can put the electronic file or internet link of user manual of equipment into the CBEH for easy access of user.

**Sample Screenshot**

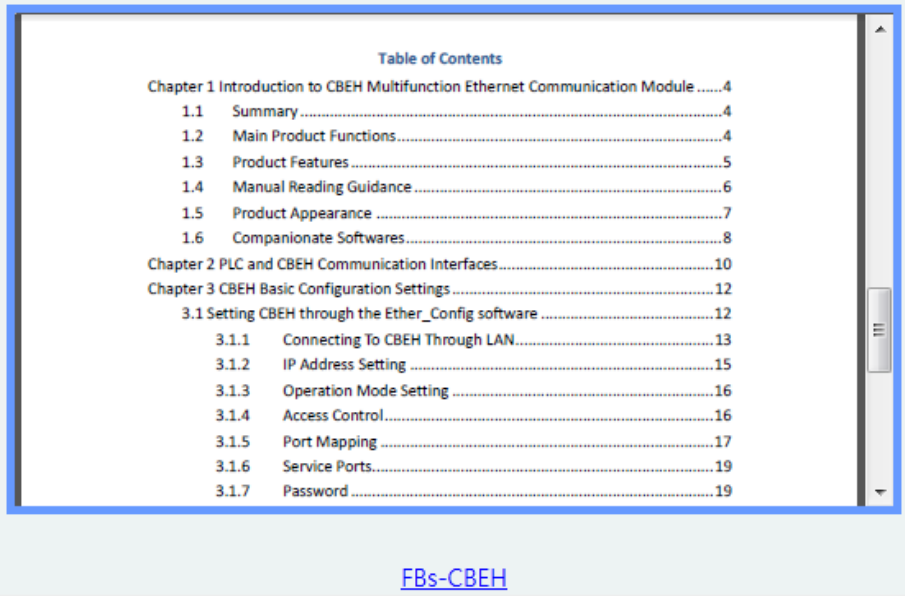

**Setting Method**

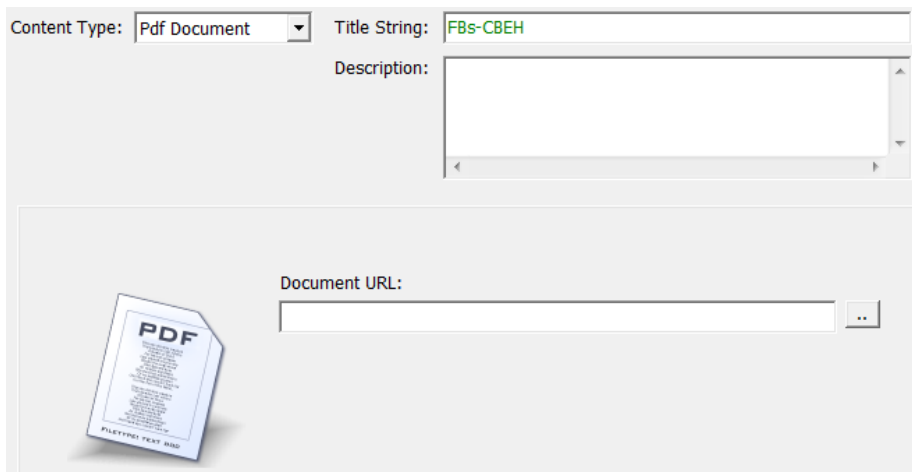

**Content Type :** Select “PdfDocument”

**Title String:** The title description of this control item.

In this example, FBs-CBEH user’s manual is embedded directly into the web page. If the visibility of embedded document is not enough can click the link text



underneath the document to open another stand along window for browsing.

**Document URL** : The local file path name or internet link of embedded PDF document. When enter the local file path name, the document file will have a copy in CBEH module. The limitation of CBEH storage will restrict the size of PDF document can embed. If the content of this field is started with “http://” means document file is located in internet clouds, which means almost limitless size of PDF document.

➤ **Memo**

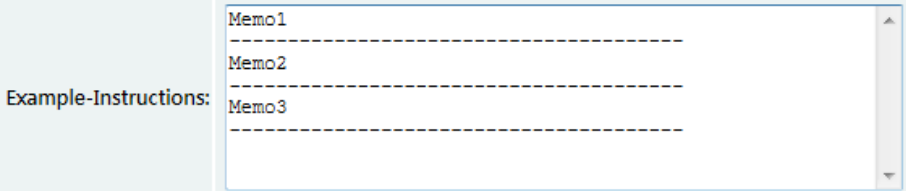
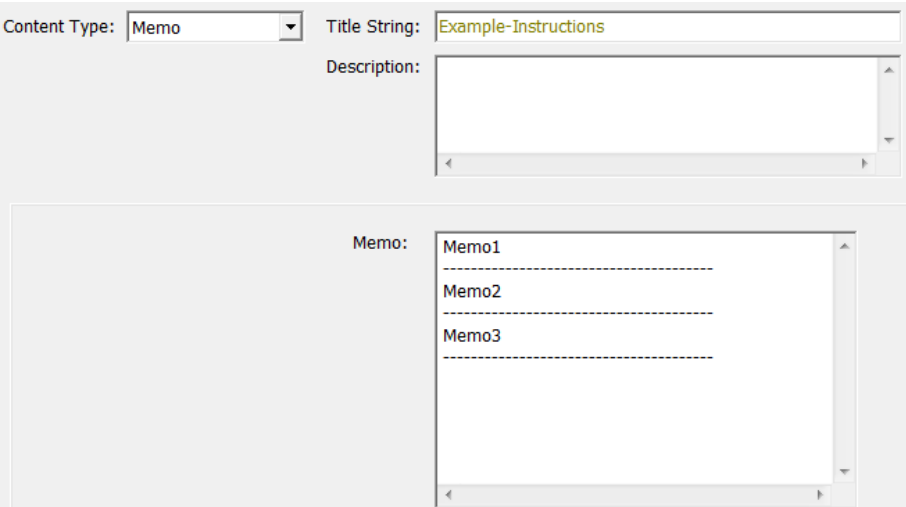
Function Description	
Section to display the description text or comments	
Sample Screenshot	
 A screenshot showing a memo display. On the left, there is a light blue box with the text "Example-Instructions:". To its right is a white rectangular area containing three lines of text: "Memo1", "Memo2", and "Memo3". Each line of text is followed by a horizontal dashed line, suggesting a list or a structured format.	
Setting Method	
 A screenshot of a configuration interface. At the top, there is a "Content Type" dropdown menu set to "Memo". To its right is a "Title String" field containing the text "Example-Instructions". Below these is a "Description" field, which is currently empty. At the bottom, there is a "Memo" field containing a list of three items: "Memo1", "Memo2", and "Memo3", each followed by a horizontal dashed line.	
<b>Content Type:</b> Select “Memo”.	
<b>Title String:</b> The title description of this memo item, such as the text displayed in the Sample Screenshot “Example-Instructions”.	
<b>Memo:</b> Fill in the text to display in the block.	

➤ **Image**

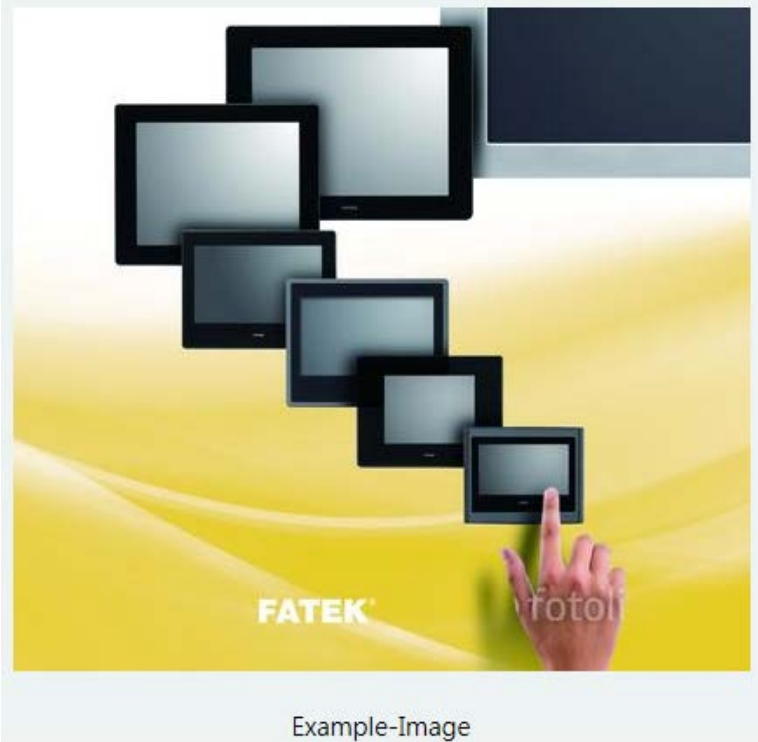
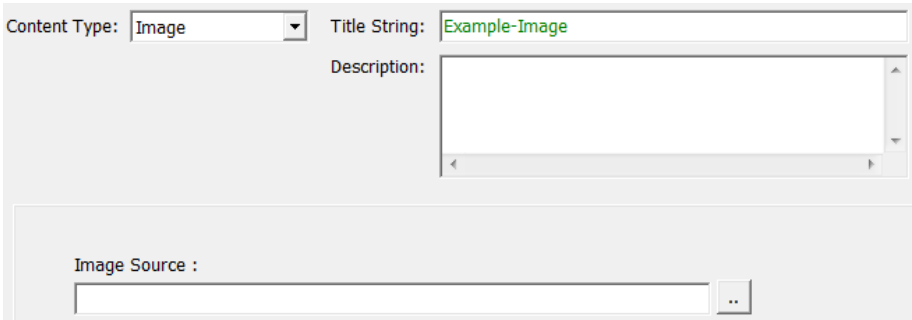
<b>Function Description</b>
The function to add images into the web page.
<b>Sample Screenshot</b>
 <p data-bbox="703 1218 890 1249">Example-Image</p>
<b>Setting Method</b>

<p><b>Content Type:</b> Select “Image”.</p> <p><b>Title String:</b> The title description of this control item, such as the text displayed in the Sample Screenshot “Example-Image”; displays below the image.</p> <p><b>Image Source:</b> Select the file path or image URL of the picture to display in the web page. When this field starts with http:// it means that the image source is a URL.</p>

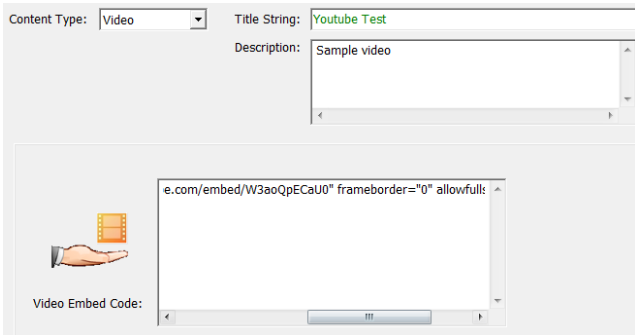
➤ **Video**

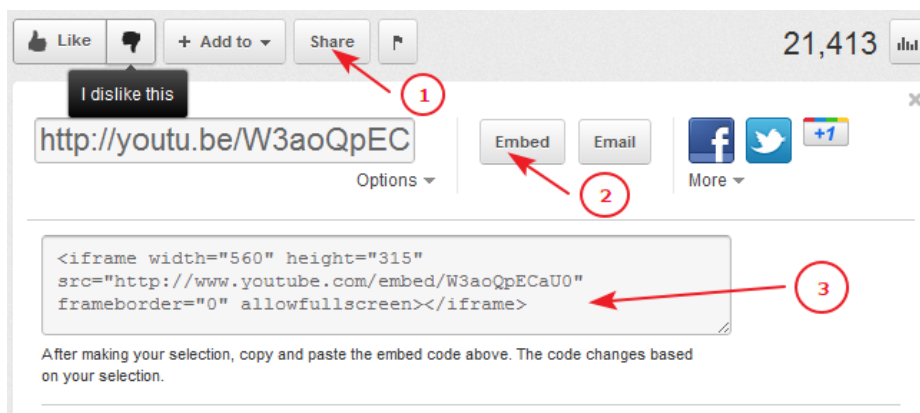
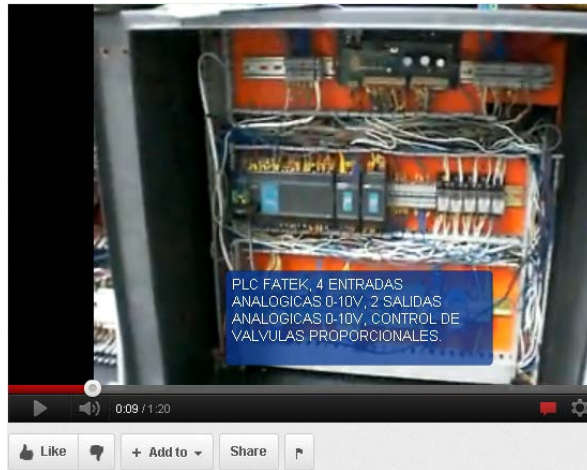
Function Description
<p>Use this function to embed an internet video for playback in the web page. It can be used as an application for machine operation demonstration.</p>
Sample Screenshot
 <p>The screenshot shows a YouTube video player interface. The video content depicts a person in a blue shirt sitting on a stool in a workshop or factory environment, working on a piece of equipment. A large play button is overlaid on the video. Below the video, the title 'Sample-Youtube' is displayed. The video player controls at the bottom show a progress bar at 0:00, a volume icon, and the YouTube logo.</p>
Setting Method
 <p>The screenshot shows a configuration window for video embedding. It has several fields: 'Content Type' is set to 'Video'; 'Title String' is 'Youtube Test'; 'Description' is 'Sample video'; and 'Video Embed Code' contains the code: <code>e.com/embed/W3aoQpECaU0" frameborder="0" allowfull:</code>. There is also a small icon of a hand holding a video frame next to the code field.</p>
<p><b>Content Type:</b> Select “Video”.</p> <p><b>Title String:</b> The title description of this video item, such as the text displayed in the Sample Screenshot “Example-Youtube Video”, displays below the Youtube video.</p> <p><b>Video Embed code:</b> The embedded code that should be included in web content in order to show a video in the web page. While the following example only describe the procedure to get embed code from Youtube, methods for other share video service are similar. First open web browser and go to the Youtube web site and locate the video hosted by Youtube as shown at below.</p>

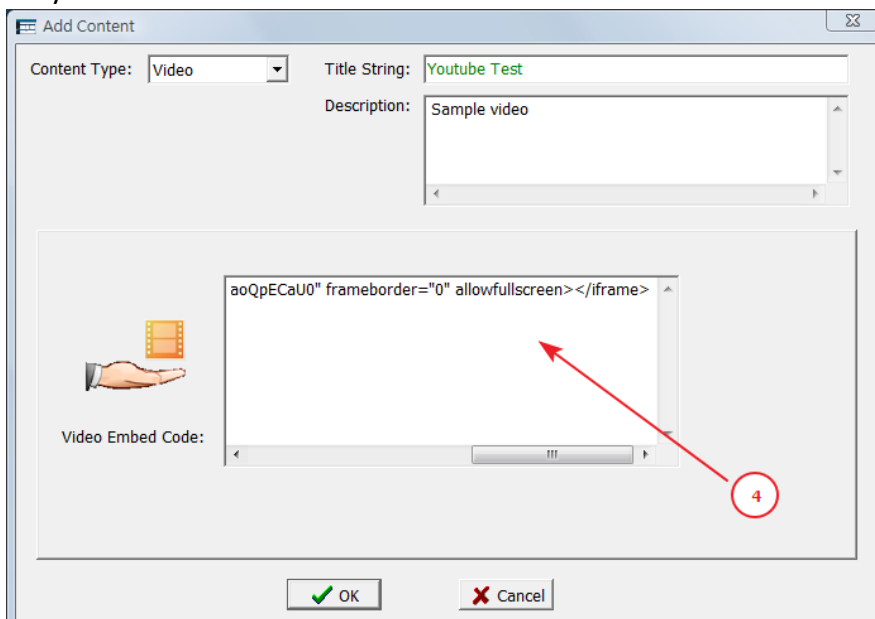

- ①. Click share button.
- ②. Click Embed button.
- ③. This section will appear after "Embed" button is depressed. Copy the text in this section.
- ④. Paste the copied text into "Video Embed Code" field to finish the embed code entry.



#### 4.4 Sending User's Webpage to CBEH

After finished creating the menu item and control contents, you must transfer the designed content to the FBs-CBEH expansion board in order to browse the content of controller based on this design with web browser.

After using the Easy Web Designer to design the navigation menu and its contents, after clicking the toolbar's  download webpage function button, the designed webpage can be transferred to the FBs-CBEH expansion board .

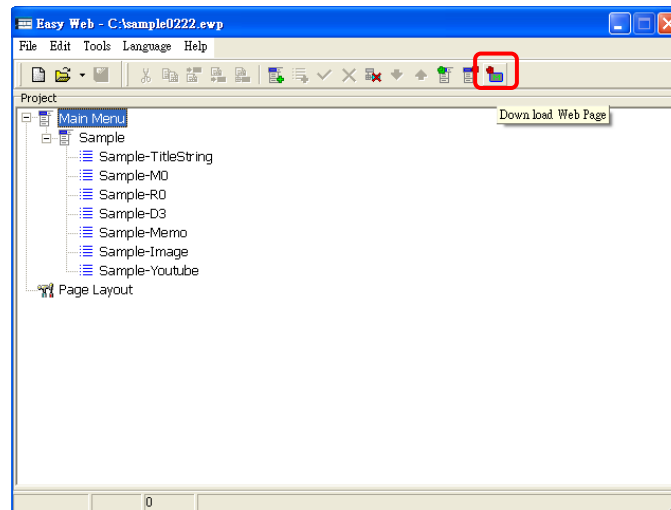

The transfer steps are as described below:

Step 1, confirm the file size of the file to send.

A hint message window will appear before sending, displaying the size of the current designed webpage content; if the content exceeds the maximum capacity (1792KB), it will not be able to download.

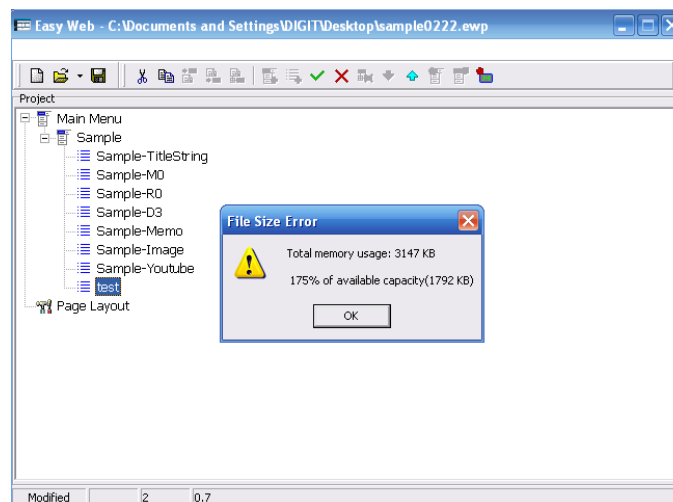

After confirming that the designed webpage content did not exceed the memory capacity provided by the FBs-CBEH expansion board, click the  button.

Step 2, target IP and password input.

Before start to transfer the webpage contents, the Web Page Transfer window will appear. Please fill in the IP address of the FBs-CBEH expansion board for downloading in the "Target IP", and enter the correct **System Password** in the "Password" field,

and then press the **Start Download** button to execute the download.

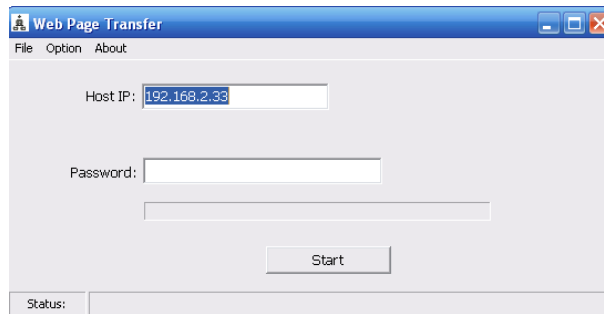

Step 3, confirm the sending progress.

While downloading the current transfer progress will be shown; it is used to confirm whether the transfer is executing normally. When the transfer is complete, the hint message window "File Transfer Done" will appear, indicating that the file transfer is complete.

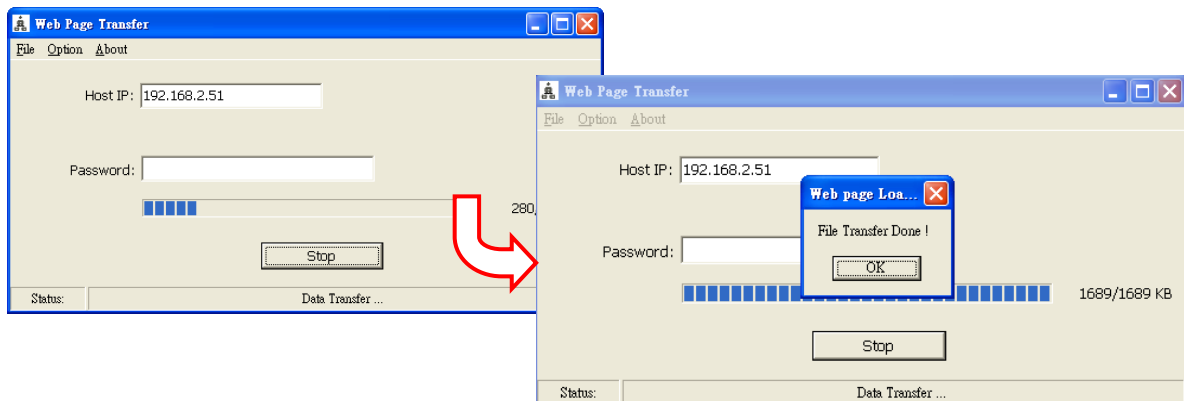

## 4.5 Setup optional parameters

Easy Web Designer provides a consistent way to setup the optional parameter which can control the extra page style and other future features. The description of parameters can be applied at present time are listed as follow

Parameter	syntax	Description
svg	svg=1 (default) svg=0	Web page content representation style. if svg=1 (default), all the contents are represented by scalable vector graphic(SVG). If svg=0 the content will adopt the built in windows style. Please refer the sample example at following for illustration.
bg_hor	bg_hor =picture file name	Horizontal banner background replacement. Please put the background picture file in the "option" subdirectory under the project directory (the folder used to store *.ewp project file). Recommended background picture size is 780*70, file format in "jpg" or "gif" .If the picture size is great than recommended size it will be cropped. If smaller then it will be tilted. Please refer the sample example at following for illustration.
bg_vet	bg_vet = picture file name	Vertical banner background replacement. Please put the background picture file in the "option" subdirectory under the project directory (the folder used to store *.ewp project file). Recommended background picture size is 780*540, file format in "jpg" or "gif" .If the picture size is great than recommended size it will be cropped. If smaller, it will be tilted. Please refer the sample example at following for illustration.

### Optional Parameter Setup

Double click the **Page Layout** item on the project tree then the **Page Layout Configuration** window will be pop up.

Click **Option Lines** tab then enter the parameter lines into the memo field.

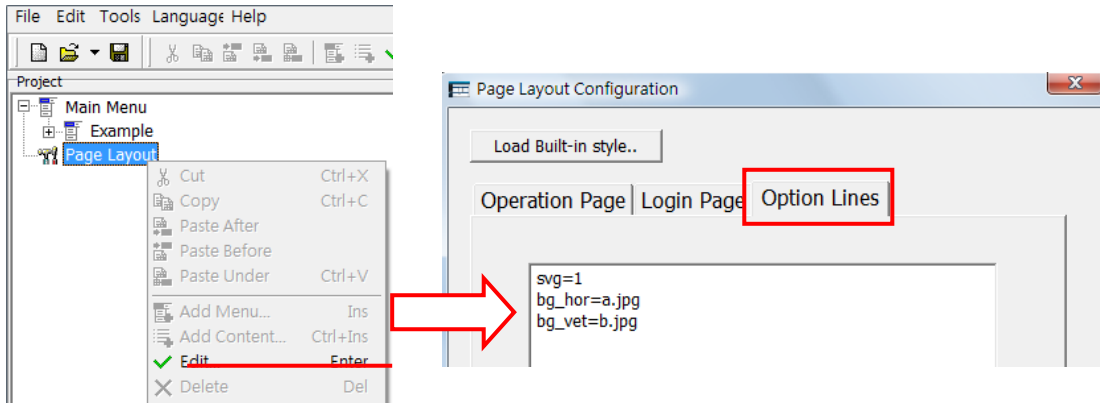







### Sample parameter setup result

#### ➤ SVG

Sample Parameter Setup	
svg=1(default) or svg=0	
Sample	
Title	
svg=1	
svg=0	
Button	
svg=1	
svg=0	

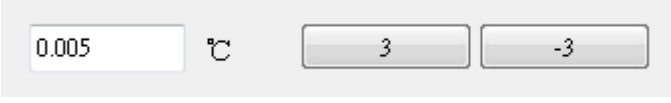

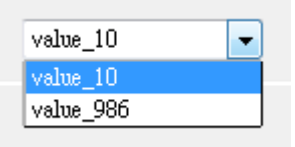
Indicator	
svg=1	
svg=0	
Value	
svg=1	
svg=0	
Value button	
svg=1	
svg=0	
List	
svg=1	
svg=0	

➤ **BG\_HOR**

**Sample Parameter Setup**

bg\_hor=a001.jpg

**Sample**

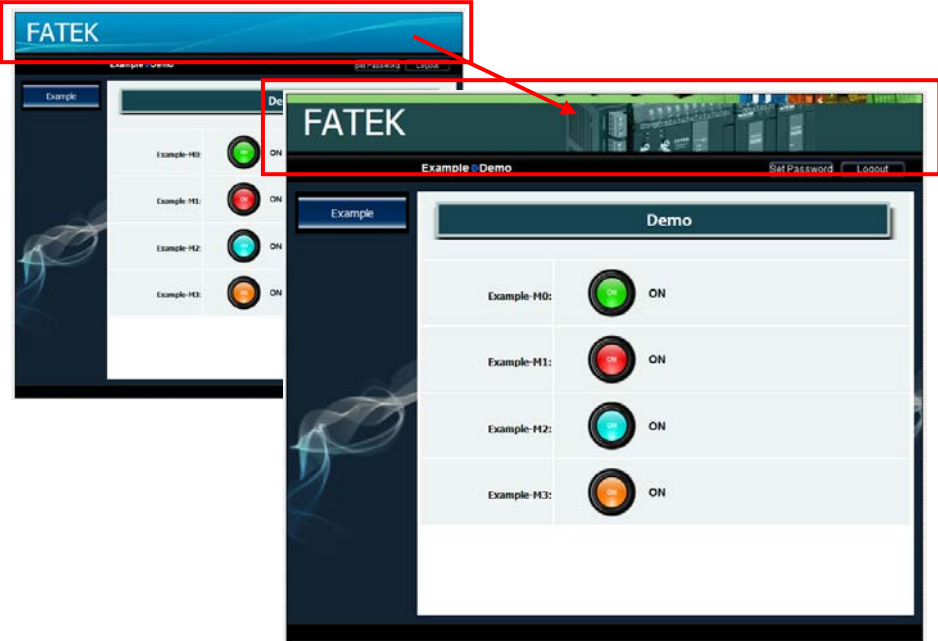

The screenshot displays the FATEK control interface. The top navigation bar features the 'FATEK' logo and a 'Demo' tab. Below this, the 'Demo' section contains four status indicators: Example-M0 (green), Example-M1 (red), Example-M2 (cyan), and Example-M3 (orange), all labeled 'ON'. A red box highlights the top navigation bar and the 'Demo' section, with an arrow pointing from the 'FATEK' logo to the 'Demo' title.

➤ **BG\_VET**

**Sample Parameter Setup**

bg\_vet=b002.jpg

**Sample**

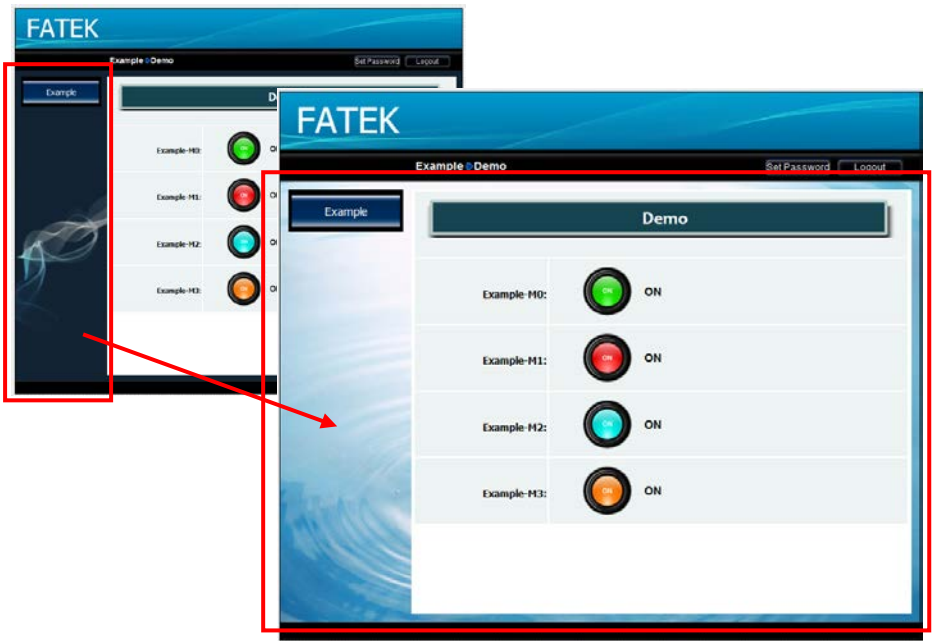

The screenshot displays the FATEK control interface. The top navigation bar features the 'FATEK' logo and a 'Demo' tab. Below this, the 'Demo' section contains four status indicators: Example-M0 (green), Example-M1 (red), Example-M2 (cyan), and Example-M3 (orange), all labeled 'ON'. A red box highlights the top navigation bar and the 'Demo' section, with an arrow pointing from the 'FATEK' logo to the 'Demo' title.

## Chapter 5 Sending Emails, Email to SMS

In terms of the maintenance immediacy, the FBs-CBEH expansion board provides the Email sending function. When special situations occurred on the workstation, an Email can be sent to notify the maintenance personnel by activating the Email send command code. In addition, through telecommunication companies that provide Email to SMS sending functions, real-time notifications can be achieved using the Email to SMS function. Before sending Emails, a tool “Email Editor” can be used to setup the messages to be sent and the email account information required to send the email. This editor can be opened from “Easy Web Designer” -> “Tools”.



The figure below is the Email Editor window; detailed descriptions of its fields are as follows:

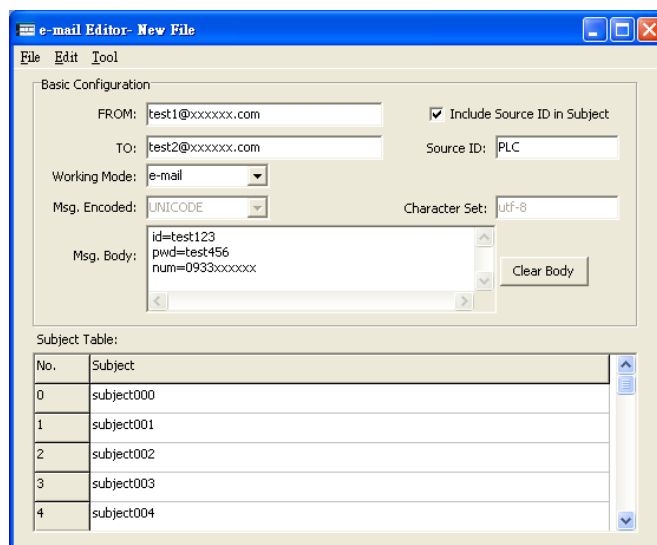

- **FROM:** Just like ordinary Emails, fill in the Email’s sender.
- **Working Mode:** In response to different application methods, the Email Editor provides two sending method settings: “Email” and “Email to SMS”.
- **TO:** Just like ordinary Emails, fill in the address of the recipient to receive this Email; multiple recipients may be entered, such as: jack@mail.com; tom@mail.com. (Note: When the operation mode is the “Email to SMS” mode, this field is the Email address of each service provider.)
- **Msg. Encoded:** Set according to the operation mode; when in “Email” mode, the coding method is fixed to “UNICODE” and “UTF-8”. And in “Email to SMS” mode, because SMS does not support Unicode, therefore users must pay special attention to the setting. If Traditional Chinese SMS must be sent, the message coding should be set as “ANSI” and the coding character set should be “big5”,

this way garbled won't be generated when the SMS is received.

- **Msg. Body:** Set according to the working mode; in "Email" mode, just like ordinary Emails, fill in the Email content to send. And when the working mode is "Email to SMS", users must refer to the setting of the service provider that provides the Email to SMS function for this field; the received SMS content is the subject content.
- **Subject Table:** Subject content that can be set as default; when actually sending the SMS, the subject sent is determined by the content of the control register (D3962) when actually sending. If it's the 0 SMS, it uses the 0 subject; if it's 1 SMS it uses the 1 subject and so on.
- **Include Source ID in Subject:** If this box is checked, the input string in the source ID field will be automatically prefixed to the subject content before sending. The format is [\*Source ID\*] Subject Content. For example if the content of the source ID is PLC, then the sent subject will turn into [\*PLC\*] Subject Content.

By using this function, the source of the message can be identified.

Below we will introduce how to send ordinary Emails and how to send Email to SMS messages.

#### How To Send Ordinary Emails

Step 1, confirm the FBs-CBEH expansion board's configuration setting.

Before sending Emails, the SMTP Server address must be filled in the IP (URL) field.

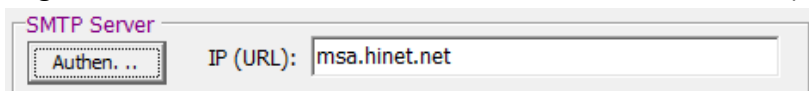

Attention: Generally, SMTP Server does not need security check. When you realized SMTP Server needs security check, please chooses  and then the following message will be shown. Fill in your login name and password of SMTP Server

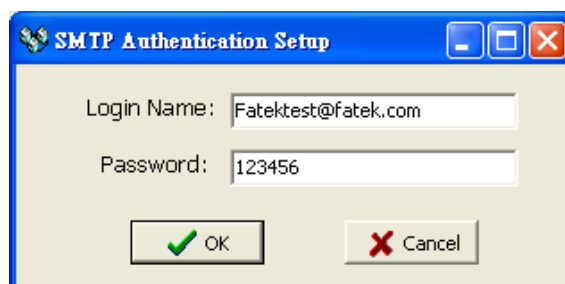

- ✧ **Login Name** : SMTP Server Account ◦ (including Domain Name)
- ✧ **Password** : SMTP Server Password ◦

Step 2, open the Email Editor and set the Email sending information.

Just like ordinary Emails, fill in information such as the Email's recipient, Email body and subject content etc.; if you want to add source ID before the subject, you can check the "Include Source ID in Subject" option.

Basic Configuration

FROM: abc@hotmail.com  Include Source ID in Subject

TO: william@fatek.com Source ID: PLC

Working Mode: e-mail

Msg. Encoded: UNICODE Character Set: utf-8

Msg. Body: test

Subject Table:

No.	Subject
0	test 000

Step 3, download the Email configuration previously set

After completing the basic Email settings, these information must be sent to the FBs-CBEH expansion board. Click "Tools" -> "Download e-mail configuration" from the main menu.

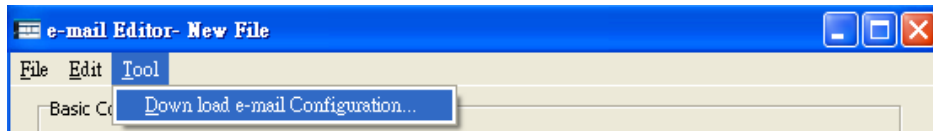

The "Email Configuration transfer" window will appear at this time; in the "Target IP" field, fill in the IP address of the FBs-CBEH expansion board to download the information, then confirm that the correct password is entered in the "Password" field and press the "Start Download" to perform the downloading.

E-mail Configuration Transfer

File Option About

Host IP: 192.168.2.51

Password:

Step 4, control the FBs-CBEH expansion board to execute Email sending.

After completed downloading the Email configuration, the Email sending function can be used; the figure below is a simple control program which uses one contact to set the Email command code register D3961's value as 0x3370, then it will execute Email sending. In addition, register D3962 can be used to control the subject number to be sent. To use the Email sending function and performing control through registers D3961~D3963, please refer to the detailed descriptions in Chapter 2.

Note	
	<p>Every time an entry of Email sending is completed, the D3961 command value must be reset to zero in order to continue to receive new send commands.</p>

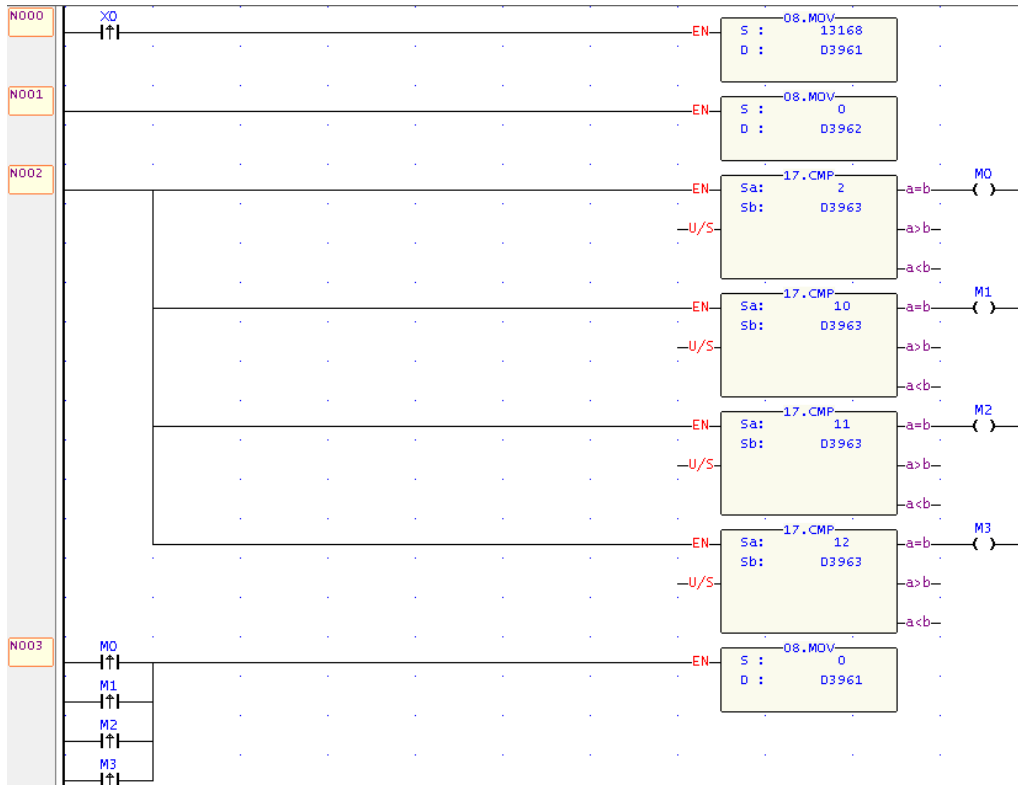

After completing the steps mentioned above, every time X0 changes from 0 to 1, and when D3962 is 0, it will receive the Email sent by the FBs-CBEH expansion board;

### How to use Email to SMS function

Step 1, confirm the FBs-CBEH expansion board's configuration setting.

Before sending Emails, the SMTP Server address must be filled in the IP (URL) field.

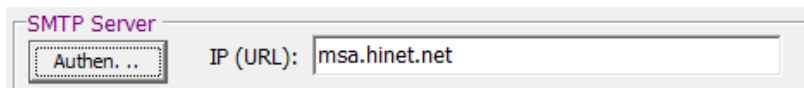

Attention: Generally, SMTP Server does not need security check. When you realized SMTP Server needs security check, please chooses **Authen. ..** and then the following message will be shown. Fill in your login name and password of SMTP Server

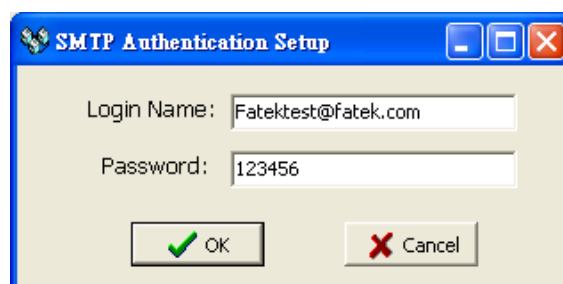

- ✧ **Login Name** : SMTP Server Account ◦ (including Domain Name)
- ✧ **Password** : SMTP Server Password ◦

Step 2, open the Email Editor and set the Email to SMS information.

To use Email to SMS, you must go through service providers that provides the Email to SMS sending function; here we will use SMS King <http://www.kotsms.com.tw/> as an example.

As shown in the figure below, in the recipient field(TO), fill in the account for Email to SMS provided by the service provider; please refer to the format provided by the service provider for the Email body. Using SMS King as an example, three information need to be entered in the Email body, the SMS King account, SMS King password, and the mobile phone number that is going to receive the SMS. (Note: Under Email to SMS mode, the SMS content received by the mobile phone is the subject content.)

Basic Configuration

FROM: .....  Include Source ID in Subject

TO: mail2sms@kotsms.com.tw Source ID: PLC1

Working Mode: e-mail to SMS

Msg. Encoded: ANSI Character Set: big5

Msg. Body: id=test123  
pwd=test123  
num=0983xxxxxx

Clear Body

Subject Table:

No.	Subject
0	subject000

Step 3, Transfer the Email configuration

After completing the basic Email settings, these information must be sent to the FBs-CBEH expansion board. Click "Tools" -> "Download Email configuration" from the main menu

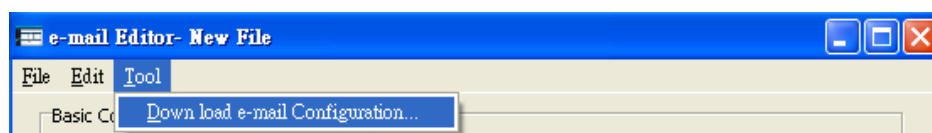

The "Email Configuration transfer" window will appear at this time; in the "Target IP" field, fill in the IP address of the FBs-CBEH expansion board to download the configuration, then confirm that the correct password is entered in the "Password" field and press the "Start Download" to perform the downloading.

E-mail Configuration Transfer

File Option About

Host IP: 192.168.2.51

Password: \_\_\_\_\_

Start

Step 4, control the FBs-CBEH expansion board to execute Email sending.

After completed uploading the Email configuration, the Email sending function can be used; the figure below is a simple control program which uses one contact to set the Email command code register D3961's value as 0x3370, then it will execute Email sending. In addition, register D3962 can be used to control the subject number to be sent. To use the Email sending function and performing control through registers D3961~D3963, please refer to the detailed descriptions in Chapter 2.

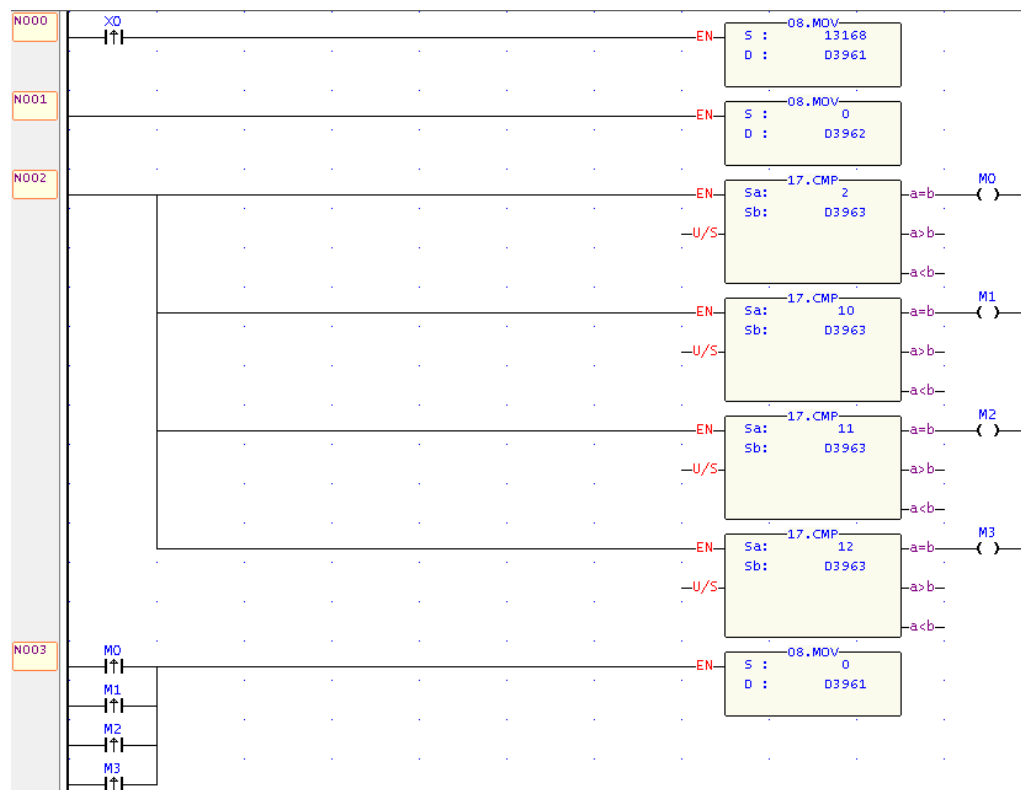

After completing the steps mentioned above, every time X0 changes from 0 to 1, and when D3962 is 0, the mobile phone will receive the SMS sent by the FBs-CBEH expansion board.



## Chapter 6 Internet Clock Synchronization

The CBEH expansion board provides the internet clock synchronization function; its main goal is to eliminate the problem of manually correcting the time on a regular basis. After the internet clock synchronization function is enabled, the system will get the standard time from the internet time server (NTP server) set by the user every 10 minutes. If the user needs to use the clock synchronization function, it can be set through the Ether\_Config software or open the browser and enter the system page provided by CBEH to perform the settings.

### 6.1 Enable the Internet Clock Synchronization Function

The steps to enable the CBEH internet clock synchronization function through the Ether\_Config software are as follows:

The first screenshot shows the 'Ethernet adaptor Configuration' window. It has a menu bar with 'File', 'Info', and 'About'. Below the menu is a section for 'Attached Media' with radio buttons for 'LAN' (selected), 'Internet', and 'RS232'. A table lists various IP addresses and their configurations:

IP Address/Name	Ethernet Address	DP Mode	Comment	Seq.
192.168.2.32 <CBEH 1>	4c:49:51:00:38:00	Server	cheh t1	1
192.168.2.51 <CBEH-TEST>	4c:49:51:00:5d:00	Client	Frank	2
192.168.2.3 <CBEH>	4c:49:51:01:00:02	Server	Not init	3
192.168.2.115 <BACnet>	4c:49:00:00:08:72	Server	not init	4
192.168.2.110 <Fatek>	4c:49:00:00:04:5b	Server	Test	5
192.168.2.171 <CME>	4c:49:51:00:00:dc	Server	not init	6
192.168.2.56 <noname>	4c:49:52:00:fe:d9	Server	\$S1	7

At the bottom of the window are buttons for 'Properties...', 'Scan', 'Exit', and 'Link Test'. A red circle with the number '1' is placed over the 'Properties...' button.

The second screenshot shows the 'Adaptor's Properties' window. It has a menu bar with 'File', 'Info', and 'About'. Below the menu is a section for 'Firmware Version' showing 'CBEH 7.0' and buttons for 'Import' and 'Export'. There are four tabs: 'Password', 'Access Control', 'Service Ports', and 'External Servers' (selected). The 'External Servers' tab contains several sections:

- NTP Server:** A checked 'Enable' checkbox, an 'IP (URL)' field with 'time-a.nist.gov', and a 'Time Zone' dropdown menu set to 'GMT+08:00'. A red circle with the number '2' is over the 'External Servers' tab, a red circle with '3' is over the 'Enable' checkbox, and a red circle with '4' is over the 'IP (URL)' field.
- SMTP Server:** An 'IP (URL)' field with 'msa.hinet.net'.
- Service Callback Server:** A 'Port' field with '5700' and an 'IP (URL)' field with '192.168.2.19'.
- DNS Server:** A 'Primary IP' field with '168.95.1.1' and a 'Secondary IP' field with '168.95.1.2'.

At the bottom of the window are 'OK' and 'Cancel' buttons.

- ① Move the mouse cursor to the line that includes the CBEH expansion board, double-click it or click the **Properties...** button to enter configuration setting.
- ② Select the External Servers setting page.
- ③ Check the Enable under NTP Server.
- ④ Enter the internet time server's IP address/URL and application location's time zone.

Steps to enable the CBEH internet clock synchronization function through a web browser are as follows:

- ① Open the web browser and enter the CBEH IP address.
- ② Select the system page and enter the password to log in (Please refer to Chapter 3.2 for detailed operation steps)

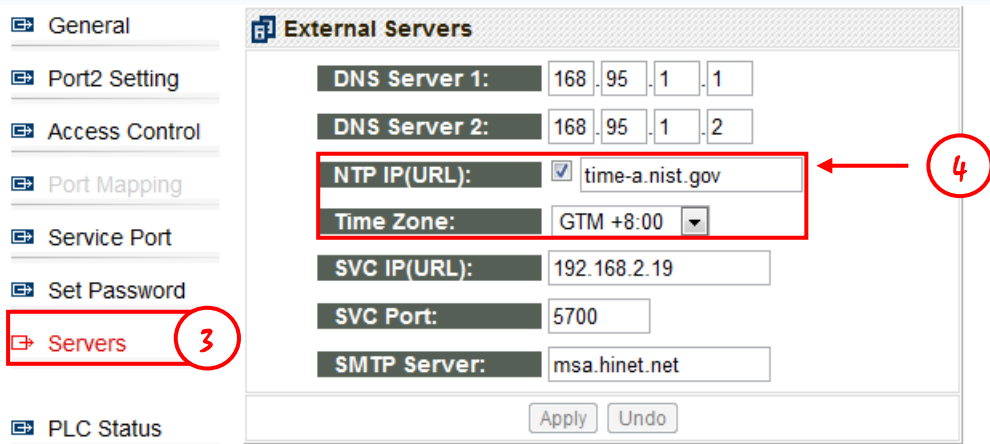

- ③ Select the Servers setting page
- ④ Check the box to the right of NTP Server and enter the internet time server IP address and time zone.

## 6.2 Synchronization of Real Time Clock with Network Time

When using a FBs-PLC with built-in Real Time Clock, the user can use the clock synchronization function provided by CBEH to keep the calendar time accuracy within 1 second that eliminate the trouble of manually correcting the time on a regular basis. The figure below depicts the relation between the CBEH time register, PLC's internal special register and the RTC, the user only needs to move the contents of the CBEH time register to the special register within the PLC and use M1952 to control the time synchronization:

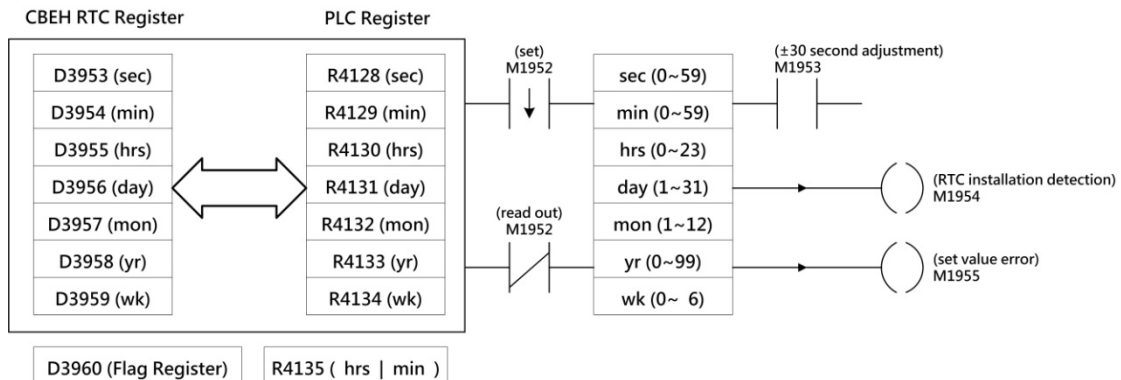

### 6.3 Sample Application

The CBEH module reads the standard time from the internet time server once every 10 minutes. Each time when receives a new data, it will increment the value of D3960 flag register and simultaneously update the contents of other calendar registers. The status change feature of the D3960 flag register can be used to control M1952 to perform data movement and RTC setting or reading. The following is a sample ladder program and its description:

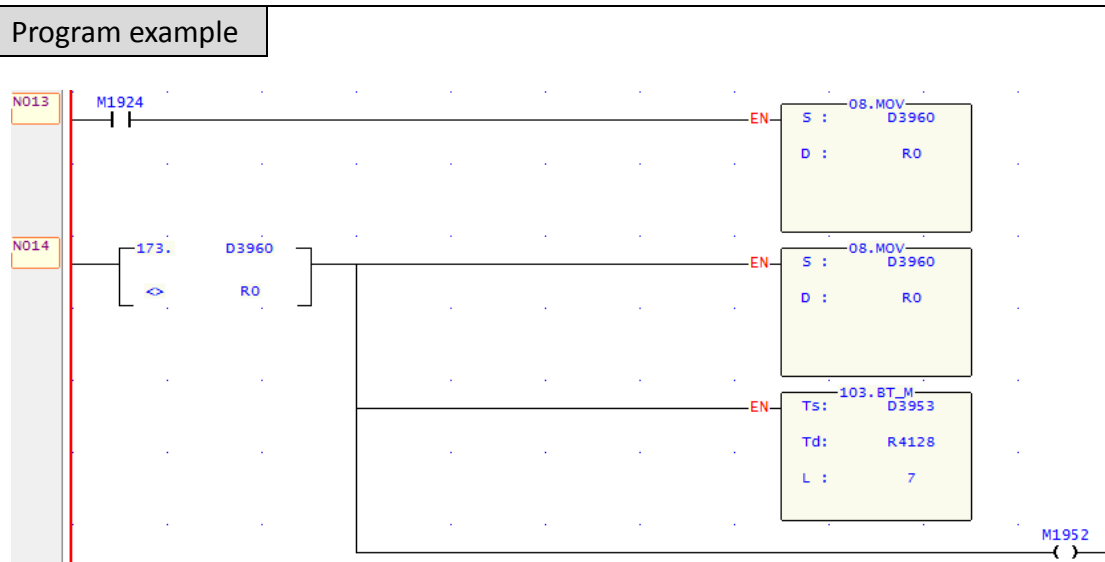

The program compares the content of R0 and D3960 to detect the changes in D3960; every time D3960 changes, the comparison output will enable the movement of the contents of D3953~D3959 to R4128~R4134 and set the value of R0 to the same as D3960 in preparation for the detection of the next D3960 change. When scanned the next time and the contents of R0 and the D3960 register is the same, therefore the comparison output is again changed of OFF and the M1952 also changes to OFF. The action of controlling M1952's status to change from ON to OFF will write the newest time in R4128~R4134 into RTC, therefore achieving the goal of automatic time synchronization.

## Chapter 7 Monitoring PLC's Internal Status Using The CBEH System Webpage

The CBEH expansion board provides the function to monitor the status of the PLC with web browser. To use this function, open a web browser and connect to the CBEH expansion board, select system page and login, then click the PLC Status page to see the following screen:

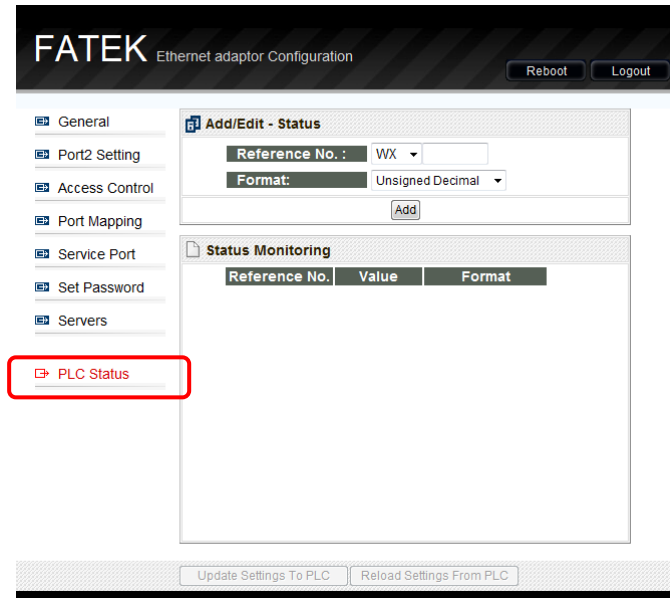

The status monitoring page has the following features:

- ✧ The data display format can be in three forms: positive or negative integers (Signed Decimal), positive integer (Unsigned Decimal) and Hexadecimal.
- ✧ It can monitor up to 5 registers/contacts at one time.
- ✧ When communication is normal there is a communication signal icon: red means sending, green means receiving; when communication is normal, the red light and green light will flicker simultaneously, if no response message is received, only the red light will flicker.

### 7.1 Adding Monitoring Points

To add new monitoring points, in the Add/Edit-Status field, enter the point information and then press the **Add** button:

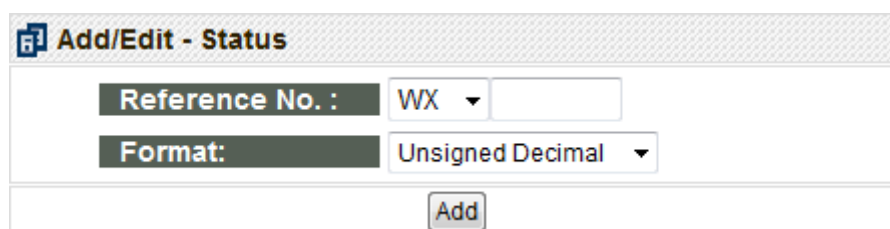

- Reference No.: The reference number of the monitored point.
- Format: Data format; can be set to positive or negative integers (Signed Decimal), positive integer (Unsigned Decimal) or Hexadecimal.



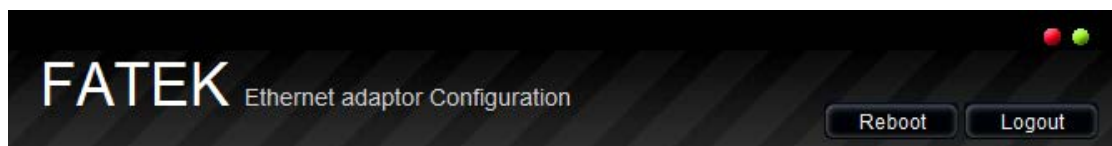

When the new point is added, the newly added data can be seen in the Status Monitoring field, as shown in the figure below:

Status Monitoring		
Reference No.	Value	Format
R0	22	Signed Decimal  

You can also notice that the communication signal on the top-right of the webpage will start to flicker, this means that the communication status with the PLC is normal:



## 7.2 Modifying and Deleting Monitoring Points

To modify a monitoring point, click the  button behind that point in the Status Monitoring field, the icon is to modify; when pressed, the icon will change to  and the highlighted parts will turn red, then you can edit the Add/Edit-Status field on top and then press the  button to complete the modification. To delete a point, please directly press the  button to delete that corresponding data entry.



**Add/Edit - Status**

**Reference No. :** R

**Format:** Signed Decimal

  

**Status Monitoring**

Reference No.	Value	Format	
R0	22	Signed Decimal	 

### 7.3 Modify the Value of Monitoring Point

To control the monitoring point content, first move the mouse cursor to the Value field of the point you want to control and click the left button. The following pop-up window will appear:

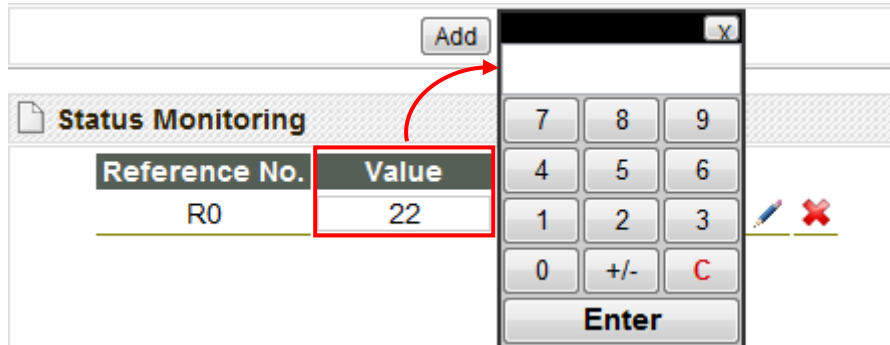

Here different pop-up windows will appear according to the data type and display formats; there are total of three types as shown below:

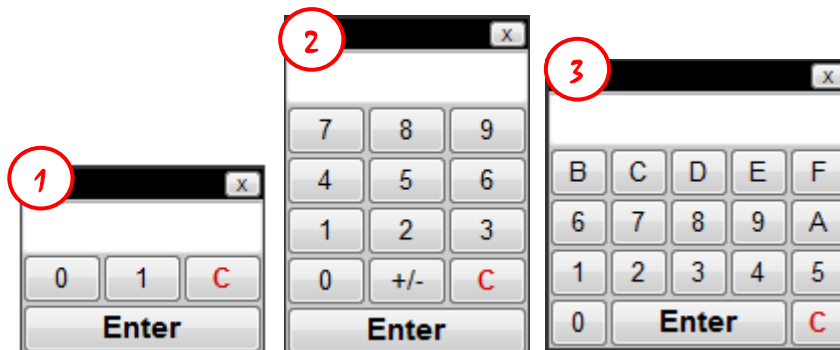

- ① When the monitoring point is a contact type such as X, Y, M, this window will appear; it can only be set to 0 or 1.
- ② When the monitoring point is a positive or negative integer or positive integer, this window will appear.
- ③ When the monitoring point is hexadecimal, this window will appear.

If the user wants to modify the value content, input the data in the popped-up window and then press the Enter button to complete the modification of the content of that point.

## Chapter 8 Active Call Back

Service Call Center (hereinafter referred to as SVC) is a remote maintenance software; when the PLC workstation's IP address is acquired using dynamic IP or if it's behind a firewall and access from outside is difficult, this software can be used to simplify the maintenance operation.

The application architecture of active call back is as shown in the figure below; it uses one computer to execute the SVC software as the maintenance center. When a workstation equipped with the FBs-CBEH module executes active call back (①), it will send a connection request (②) to the maintenance center according to the configuration setting; the maintenance center will confirm the workstation's connection request (③) and then the application program (such as Winproladder) can be automatically opened through this connection to carry out the maintenance operations (④).

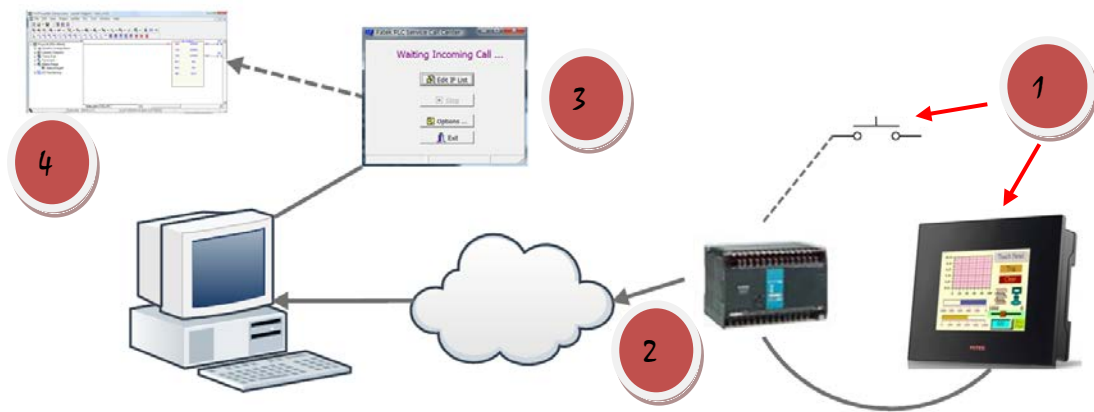

### 8.1 Option Setting Page

When applied; a computer with a fixed IP address must be set as the maintenance center and the basic settings for the Service Call Center must be completed on the maintenance center. The figure below is the option setting page when the **options** button is pressed after Service Call Center is opened; the definition of each field are as follows:

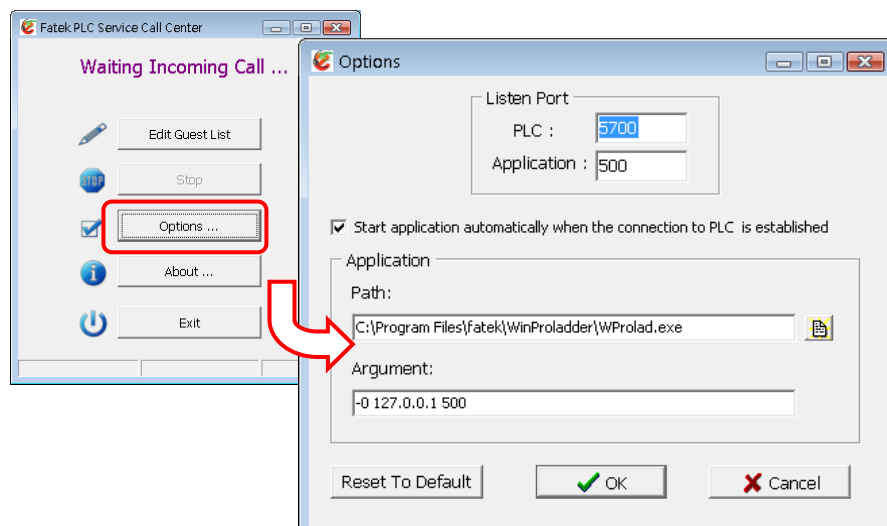

- Listen Port – PLC: Specify a communication port as the maintenance center’s external service port; the default value is 5700.
- Listen Port – Application: Specify a IP port number as the application software’s external service port. If it’s the Winproladder application software, it is set to 500.
- Start Application Automatically ...: When the workstation and maintenance center has successfully connected, if the application program needs to be automatically started up, this option must be checked.
- Application – Path: When the workstation and maintenance center has successfully connected, if the application program needs to be opened, the path of the application program to be opened must be entered here.
- Application – Argument: If additional command parameters need to be added when opening the application program, enter it in this field.

The default content of this page is set when the application program is Winproladder. Unless there are other application considerations, there are no need for modifications to the contents of this page.

## 8.2 Guest List

The main function of the guest list is when a connection request is received, a maintenance center personnel connection source identification can be provided at first time to use as a basis for follow-up processing; a simple example is shown in the figure below. First click the **Edit Guest List** button, then right-click in the guest list to add a workstation information entry; the definition of each field are as follows:

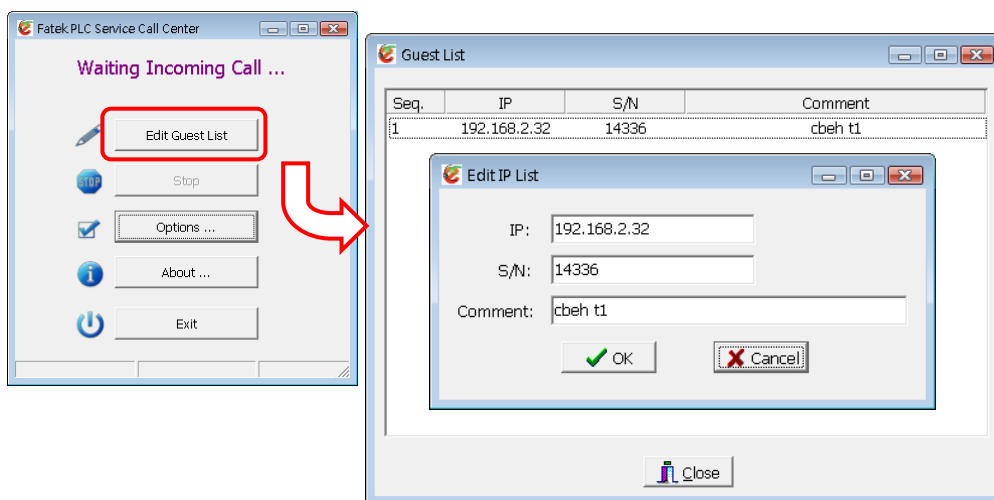

- IP: The network address of the workstation requesting connection.
- S/N: The factory serial number of the FBs-CBEH equipped by the workstation requesting the connection.
- Comment: The text description information of the corresponding remote workstation, such as company name and machine model number etc.

When the guest list is created, the following two figures are two connection requests



received by the maintenance center from different IP workstations. The contents of the IP, Description and S/N fields are provided by the workstations when connecting; and the contents of Comment are the information look up from the guest list that uses the factory serial number as the key value. In the left figure below, the connection request shows that its manufacturing serial number is 14336 and is listed in the guest list, and its IP is the same as the data created, therefore the color of the displayed information are all black; on the other hand, the serial number of the connection in the right figure below is 14336 and is listed in the guest list, but its IP is 192.168.2.32 which is different from the registry information, therefore the IP information is displayed in red as a reminder.

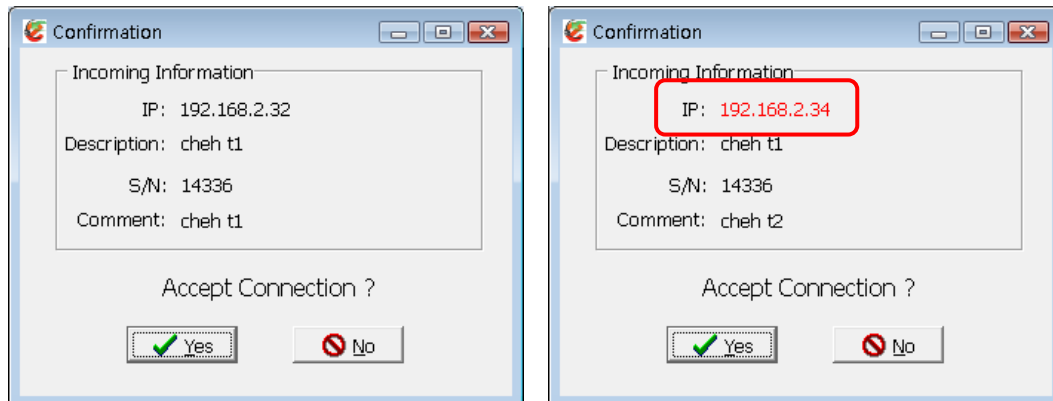

When the connection request window appears, the maintenance personnel can press the **Yes** button to accept this connection or press the **No** button to reject this connection.

### 8.3 Active Call Back Application Example

The steps to execute the active callback function are as follows:

#### Step 1, setting up the maintenance center environment

In an active call back application, first a PC with static public IP must be used as the maintenance center, then execute the SVC software the complete the basic settings on the option setting page; at this time, the maintenance center is in ready status.

#### Step 2, FBs-CBEH expansion board configuration setting

On the FBs-CBEH remote site that you want to execute active call back, its Service Call Back Server configuration contents must be the same as the maintenance center in order to ensure the communication between the workstation and the maintenance center.

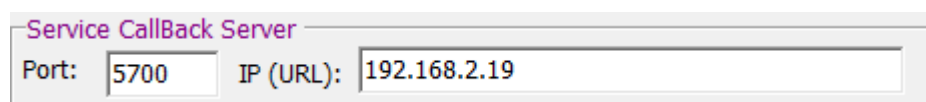

#### Step 3, execute the active call back program

After confirming that the workstation's Service Call Back Server configuration setting is correct, you can execute the active call back function. To use the active call back function, it can be controlled using the registers D3950 and D3951; please refer to Chapter 2 for detailed descriptions.

The next figure is a simple control program; it uses the X0 contact to start up the active call back action. When X0 is pressed, the active call back command code register D3950 will be set to 3359H, which will execute the active call back. In addition, the status of register D3951 can be used to monitor the operation execution of the call back. In the example, when the connection is successful, Y1 will be ON. When connection failed, Y2 or Y3 will be ON. When connection is terminated, D3951 must be set to 0 in order to accept the new call back request command.

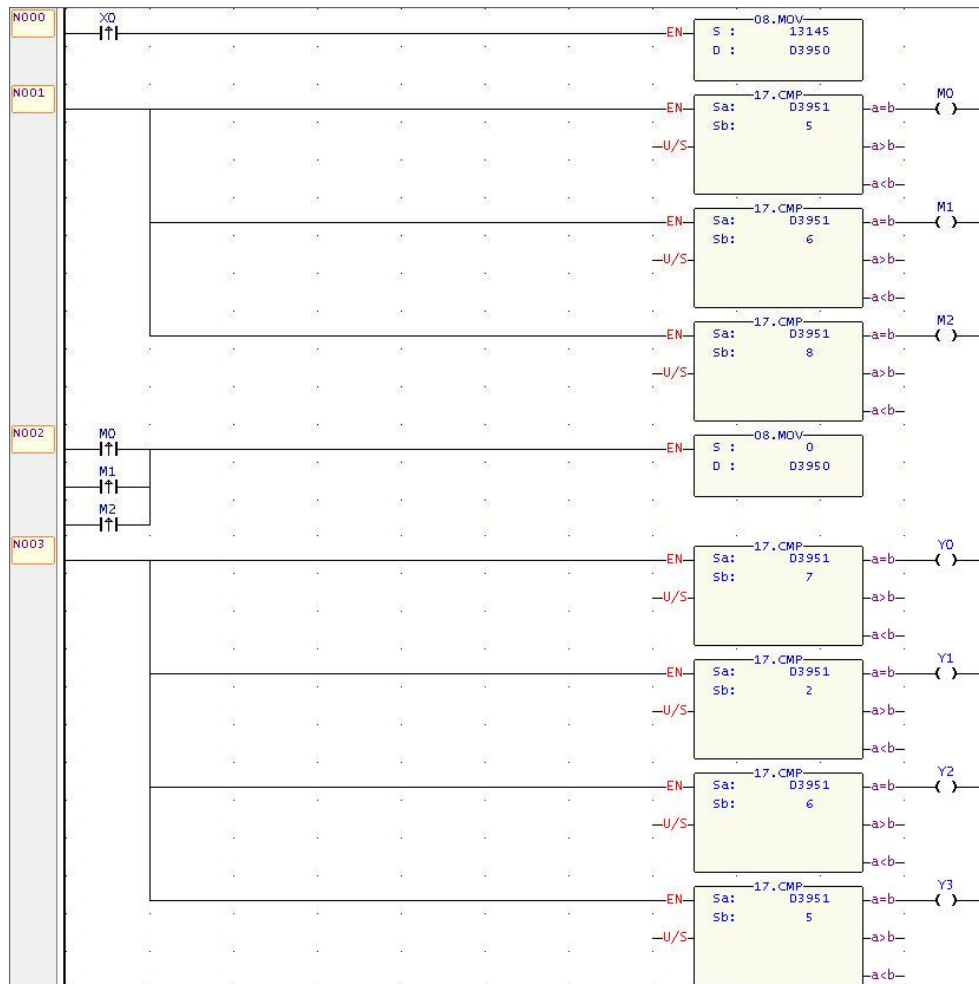

#### Step 4, confirm connection request

After the workstation sent out the active call back command, the connection request information will be displayed at the maintenance center. At this time, the maintenance center can decide whether to establish the connection with the workstation and start up the application program.

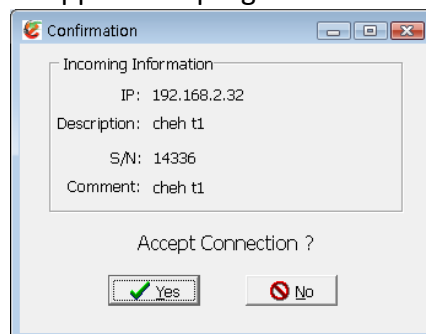

## Chapter 9 CBEH Firmware Update

When a new version of the CBEH module firmware is released, the user can choose whether to update it according to their needs. If update is needed, users can go to FATEK's official website to download the image file of the new version, and use the ether\_cfg software tool to perform the update.

※Note: Firmware update function of Ether\_cfg software only support CBEH product.

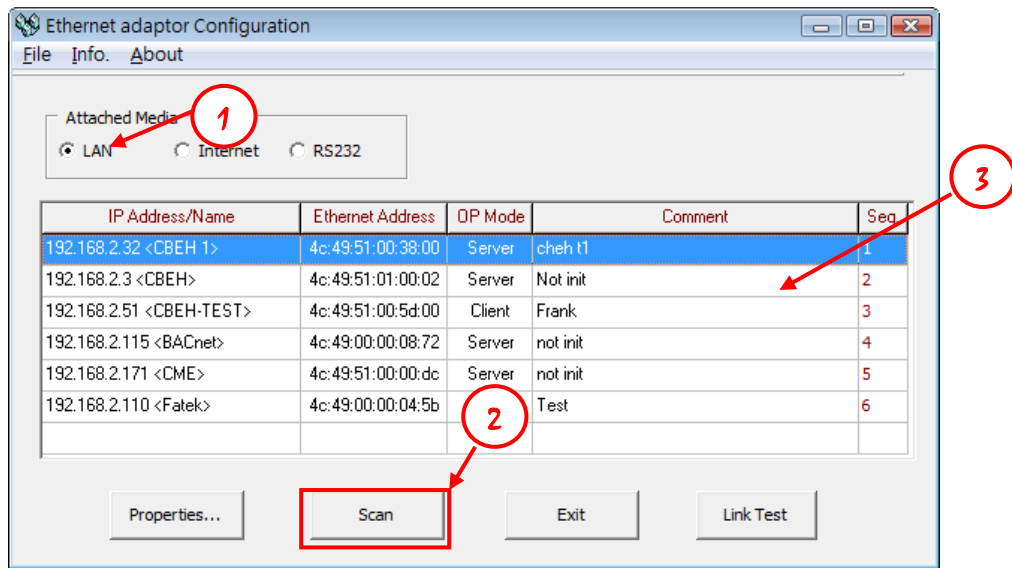

The firmware update can only be performed under a local area network environment, please install the module which includes the CBEH expansion board in a local area network environment, then execute the Ether\_Cfg software and follow the following steps to perform the firmware update operation:



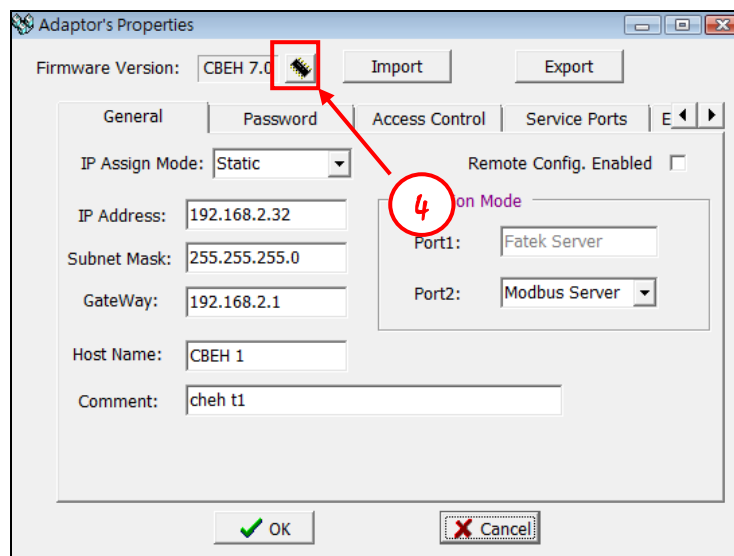

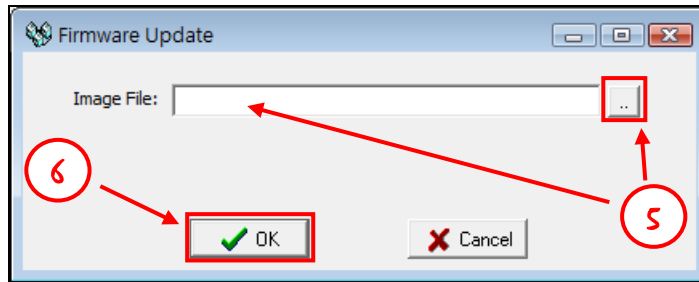
- ① In the Attached Media section select LAN.
- ② Click the **Scan** button and it will start to scan the network modules online.
- ③ The detected module will be displayed in the table at the middle of the window, move the mouse cursor to the CBEH expansion board data row that you want to set, and double-click to enter the configuration setting window as shown below.





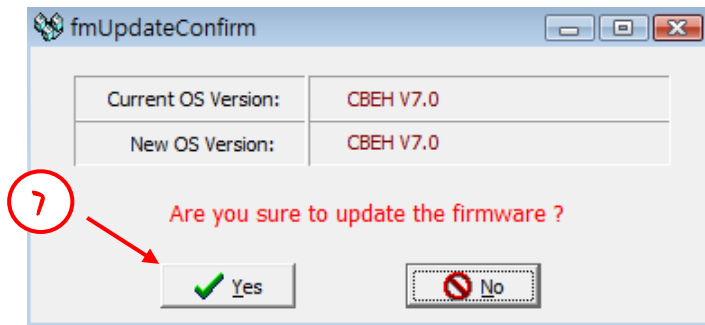

- ④ Press the  button.
- ⑤ Edit the “Image file” entry; where you can directly enter the file location or press the  button to select the firmware file location through the window.  
Note: The file extension of the firmware file is \*.os.
- ⑥ Press the  button.

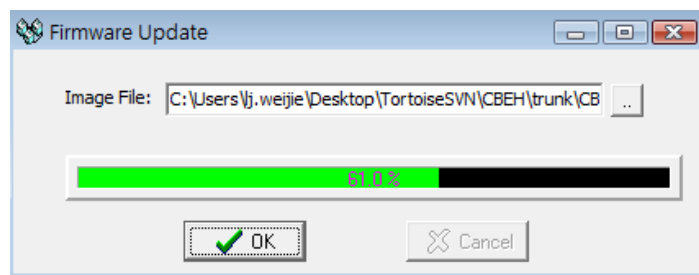

- ⑦ The software will display the CBEH’s current firmware version alongside the firmware version selected by the user, and ask the user whether to update. If you are sure you want to update, press the  button to directly start the update operation. If you do not want to update because the version number is the same or due to other elements, you can also press the  button to exit the update operation.



Note	
	<p>Please take note of the following items when updating the firmware:</p> <ol style="list-style-type: none"> <li>1. Do not interrupt the CBEH’s power during update.</li> <li>2. If the update operation was interrupted due to unknown issues, you can turn off the power and restart CBEH and perform the update operation again.</li> </ol>