



Introduction

FBS-2DA is one of the analog output modules of FATEK FBs series PLC. It provides 2 channels of 14 bit D/A output. Base on the different jumper settings it can provide varieties of current or voltage output signal. The output code can be configured as unipolar or bipolar which makes the relation of output code and real output signal more intuitive. For safety, the output signal will be automatically forced to zero(0V or 0mA) when the module is not serviced by CPU for 0.5 second

Specifications

Total Channels -2 Channels

Resolution- 14 bit

Signal Resolution - 0.3mV(Voltage), 0.61uA(Current)

I/O Points Occupied -

2 RO(Output Register)

Conversion Time- Updated each scan

Accuracy- $\pm 1\%$

Max. and Min. output loading-

Voltage Output- 500~1M Ω

Current Output- 0~500 Ω

Output Range-

-10~+10V, -5~+5V, 0~10V, 0~5V

-20~+20mA, -10~+10mA, 0~20mA, 0~10mA

Isolation- Transformer(Power) and photo-coupler(Signal)

Indicator(s) - 5V PWR LED

External Power and Consumption-

24V-15%/+20%,

70mA max.

Internal Power Consumption- 5V, 20mA

Operating Temperature- 0 ~ 60 °C

Storage Temperature- -20 ~ 80 °C

Dimensions- 40(W)x90(H)x80(D) mm

Dimensions

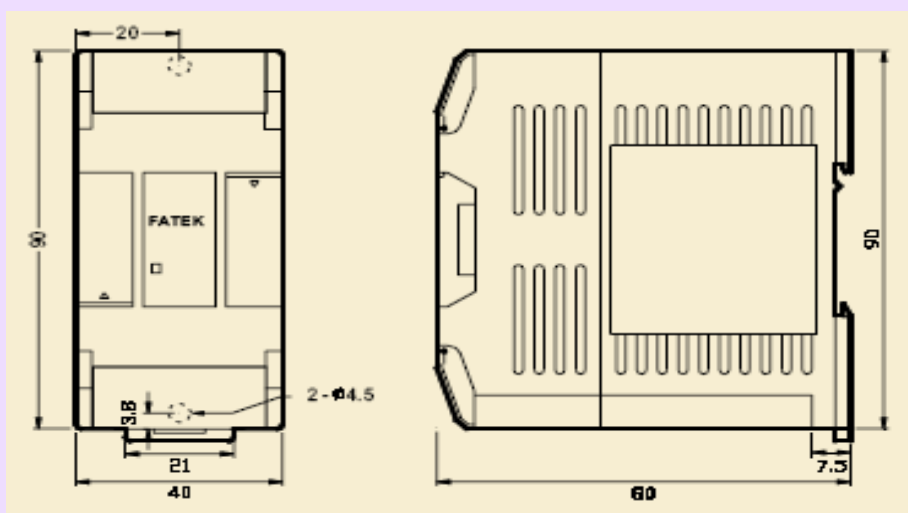

FBs-2DA

2 Channels Analog Output Module

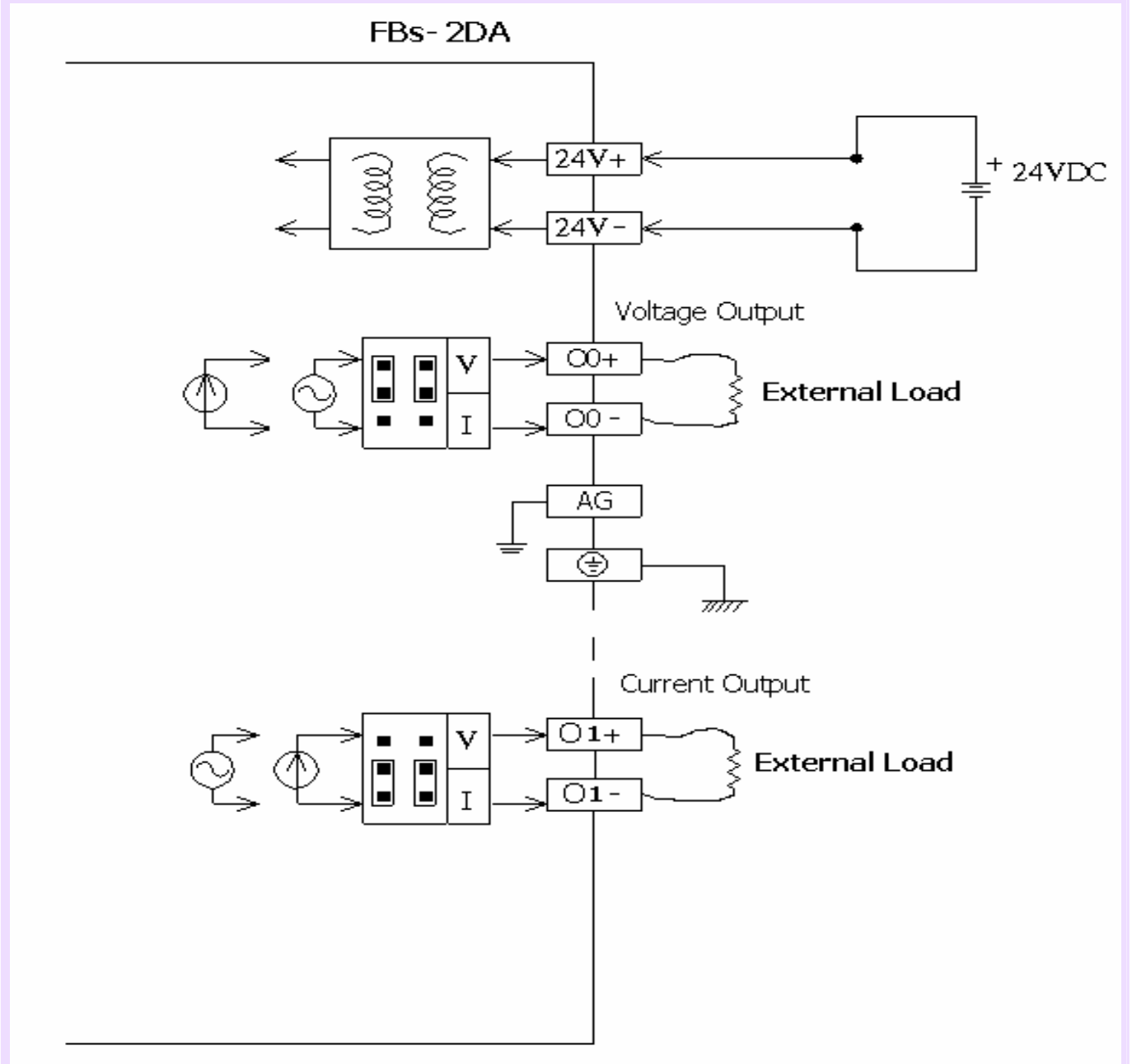

Wiring Diagram



Jumper Setup

Output Code Format Selection

There are two formats of output code can be selected, one is Unipolar and the other is Bipolar. The range of the Unipolar code value is 0~16383 while the Bipolar is -8192~8191. The extreme two ends of the code value corresponding to the minimal and maximal analog output level respectively. For example, if the analog signal is set to -10V~+10V range, for the same code value 0, the Bipolar code will result 0V output, while the Unipolar code will result -10V output, for the code value 8191, the Bipolar code will result 10V output, while the Unipolar code will result 0V output. The JP1 are shared for CH0, CH1 which means both channels can not configure to different output code format.







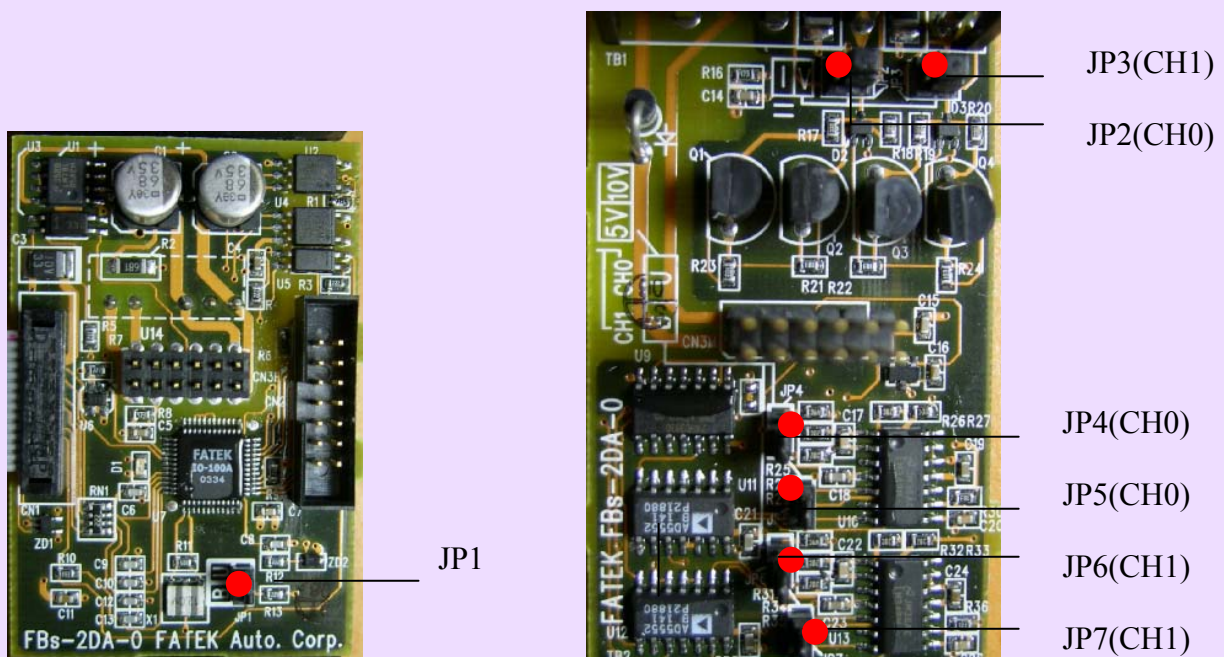





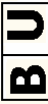
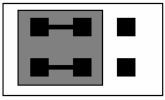

Code Format	Range	JP1 Setting
Bipolar	-8192 ~ +8191	
Unipolar	0 ~ 16383	

Output Signal Type Selection

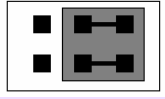
The output signal type of each channel can be set individually. There are three jumpers for each channel to control the output signal type. The corresponding jumpers for each channel are shown at below:



Please lookup the arrangement of jumper from the following table according to the desired output signal type.

Signal Type	JP2/JP3 	JP4/JP6 	JP5/JP7 
0~20mA			
-20mA~+20mA			
0~10mA			
-10mA~+10mA			
0~10V			
-10V~+10V			
0~5V			
-5V~+5V			

The JP2,JP4,JP5 jumpers are used for CH0 output signal type setting while the JP3,JP6,JP7 jumpers are used for CH1.

The default factory settings of FBs-2DA analogue output module are

Output code format – Bipolar(-8192~+8191)

Output signal type and range – Bipolar(-10V ~ +10V)

For those applications that require the setting differ than the above default setting should make some modification according to the tables listed above