



Introduction

FBs-4A2D is one of the analog I/O modules of FATEK FBs series PLC. For analog output it provides 2 channels of 14 bit D/A output. Base on the different jumper settings it can provide varieties of current or voltage output signal. The output code can be configured as unipolar or bipolar which makes the relation of output code and real output signal more intuitive. For safety, the output signal will be automatically forced to zero(0V or 0mA) when the module is not serviced by CPU for 0.5 second.

For analog input it provides 4 channels A/D input with 12 or 14 bit effective resolution. Base on the different jumper settings it can measure the varieties of current or voltage signal. The reading value is represented by a 14 bit value no matter the effective resolution is set to 12 or 14 bit The output code also can be configured as unipolar or bipolar which makes the relation of input code and real input signal more intuitive.. In order to filter out the field noise imposed on the signal, it also provides the average of sample input function.

Specification

Analog Input

Total Channels - 6 CH

Resolution- 14 or 12 bit

Signal Resolution - 0.3mV(Voltage), 0.61uA(Current)

I/O Points Occupied - 6 RI(Input Register)

Conversion Time- Updated each scan

Accuracy- $\pm 1\%$

Max. Absolute Input Rating-

$\pm 15V$ (Voltage), 30mA(Current)

Software Filter- Moving average

Average Samples- 1~16 configurable

Input Impedance- 63.2K Ω (Voltage), 250 Ω (Current)

Measurement Range-

-10~+10V, -5~+5V, 0~10V, 0~5V

-20~+20mA, -10~+10mA, 0~20mA, 0~10mA

Analog Output

Total Channels -2 Channels

Resolution- 14 bit

Signal Resolution - 0.3mV(Voltage), 0.61uA(Current)

I/O Points Occupied -

2 RO(Output Register)

Conversion Time- Updated each scan

Accuracy- $\pm 1\%$

Max. and Min. output loading-

Voltage Output- 500~1M Ω

Current Output- 0~500 Ω

Output Range-

-10~+10V, -5~+5V, 0~10V, 0~5V

-20~+20mA, -10~+10mA, 0~20mA, 0~10mA

Common Specification

Isolation- Transformer(Power) and photo-coupler(Signal)

Indicator(s) - 5V PWR LED

External Power and Consumption-

24V-15%/+20%,

100mA max.

Internal Power Consumption- 5V, 20mA

Operating Temperature- 0 ~ 60 °C

Storage Temperature- -20 ~ 80 °C

Dimensions- 40(W)x90(H)x80(D) mm

FBs-4A2D

Analog A/D&D/A Combo Module

Dimensions

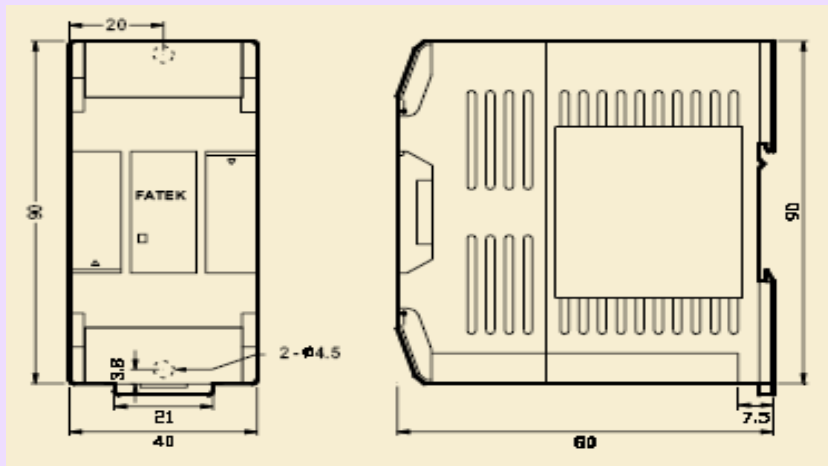

Wiring Diagram

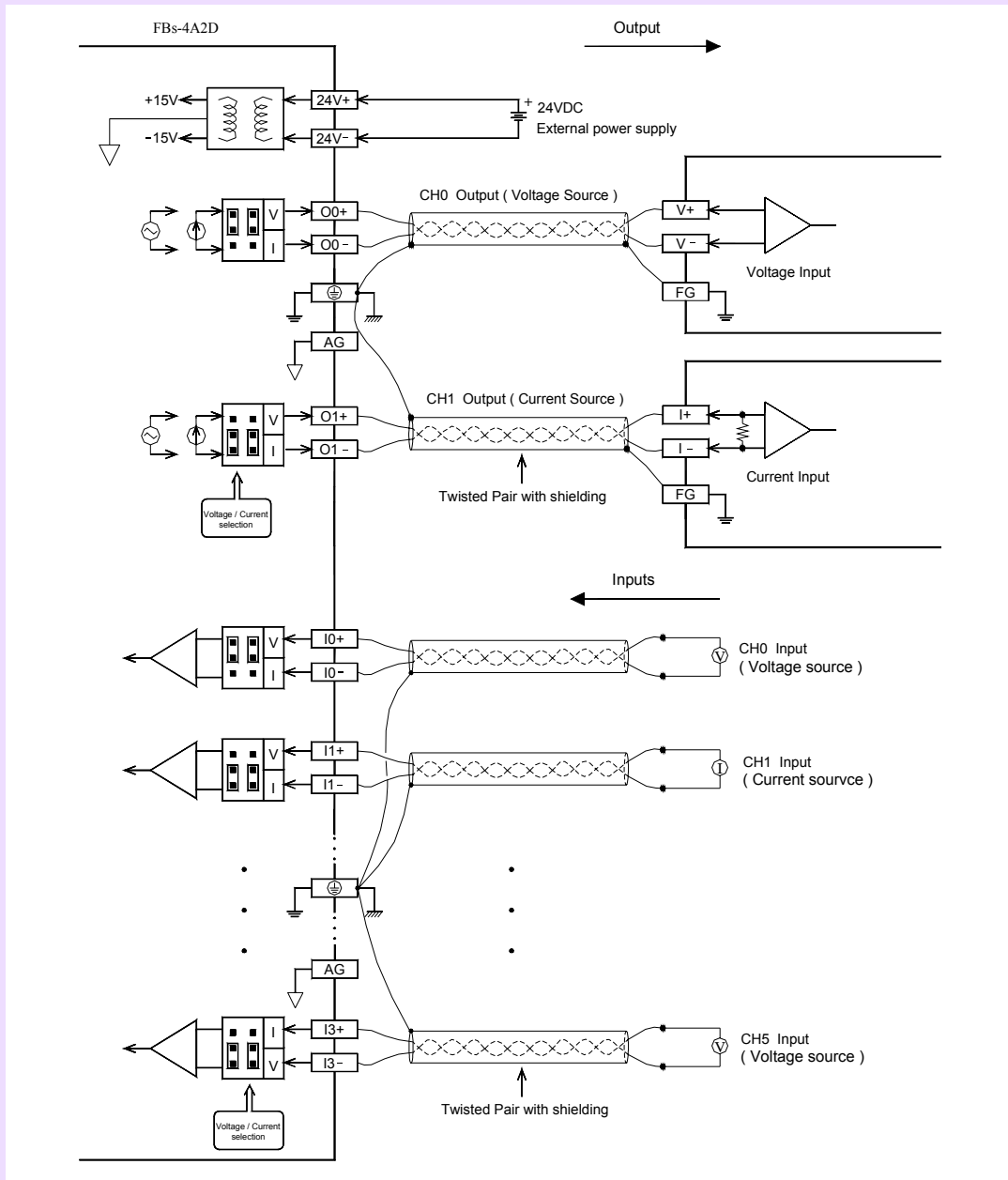

FBS-4A2D

Analog A/D&D/A Combo Module

D/A Jumper Setup

Output Code Format Selection

There are two formats of output code can be selected, one is Unipolar and the other is Bipolar. The range of the Unipolar code value is 0~16383 while the Bipolar is -8192~8191. The extreme two ends of the code value corresponding to the minimal and maximal analog output level respectively. For example, if the analog signal is set to -10V~+10V range, for the same code value 0, the Bipolar code will result 0V output, while the Unipolar code will result -10V output, for the code value 8191, the Bipolar code will result 10V output, while the Unipolar code will result 0V output. The JP1 are shared for CH0, CH1 which means both channels can not configure to different output code format.

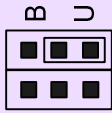
Format	JP1	Code Range	Corresponding Output
Bipolar	 (D/A)	-8192 ~ 8191	-10V ~ 10V(-20mA ~ 20mA) -5V ~ 5V(-20mA ~ 20mA)
Unipolar	 (D/A)	0 ~ 16383	0V ~ 10V(0mA ~ 20mA) 0V ~ 5V(0mA ~ 10mA)

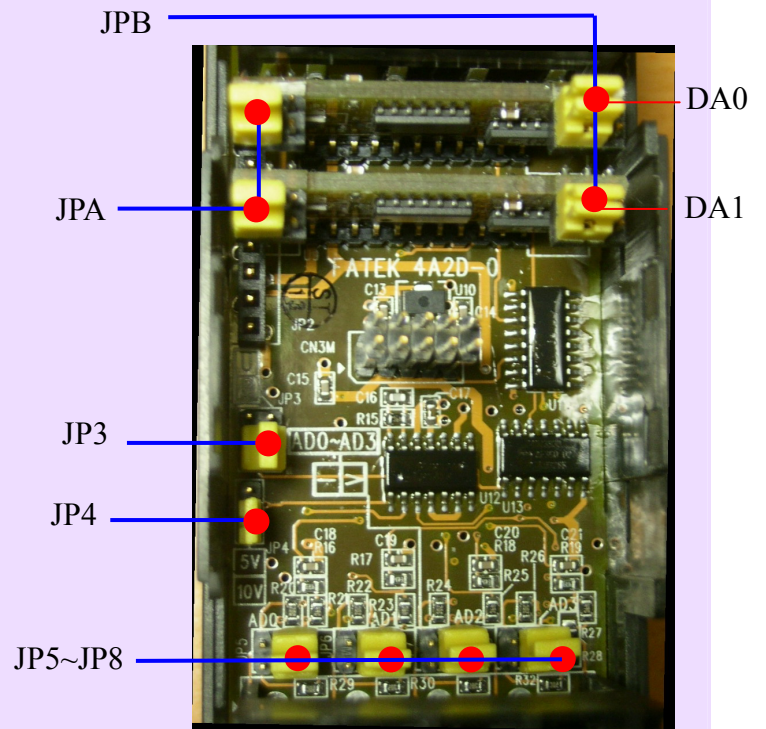
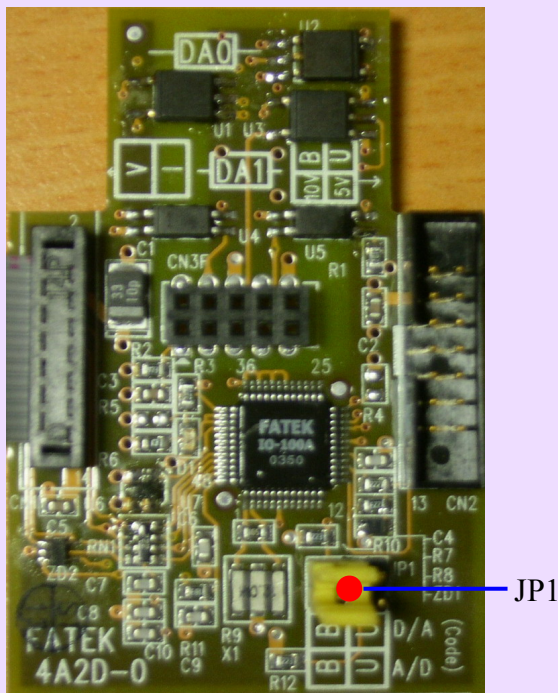

Output Signal Type Selection

Please refer the above picture for the location of JPA & JPB. The upper row of JPA & JPB is for CH0 D/A, while the second row of JPA & JPB is for CH1 D/A.

Signal Type	JPA (Voltage/Current) Setup	JPB (Range&Polarity) Setup
0V ~ 10V		
-10V ~ 10V		
0V ~ 5V		
-5V ~ 5V		
0mA ~ 20mA		
-20mA ~ 20mA		
0mA ~ 10mA		
-10mA ~ 10VmA		

A/D Jumper Setup

Input Code Format Selection

There are two input data formats can be selected which are bipolar and unipolar. The range of input value is 0~16383 for unipolar format while bipolar is -8192~8191. The two extreme values of each range corresponding to the minimal and maximal input signal. For example, if chose the -10V~+10V type signal, for 10V input signal the input value is 16383 for unipolar format while the bipolar format is 8191. Normally the input code format setting is consistent with input signal type (bipolar coded for bipolar input signal, unipolar coded for unipolar input signal). Only when use the FUN32 for offset conversion should set the bipolar code for unipolar input signal (Please refer the FUN32 description). The code format of all input channels are set by the same JP1 jumper. The location and the setting of jumper of JP1 are shown at below

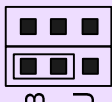
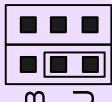
Code Format	JP1 Setup	Code Range	Corresponding Input
Bipolar	 JP1 (A/D)	-8192 ~ 8191	-10V ~ 10V(-20mA ~ 20mA) -5V ~ 5V(-20mA ~ 20mA) 0V ~ 10V(0mA ~ 20mA)
Unipolar	 JP1 (A/D)	0 ~ 16383	0V ~ 10V(0mA ~ 20mA) 0V ~ 5V(0mA ~ 10mA)

Voltage/Current input signal type setting

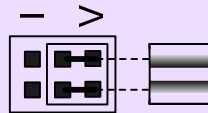
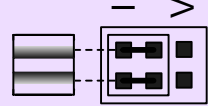
Signal Type	JP5 ~ JP8
Voltage	
Current	

A/D Signal Type selection

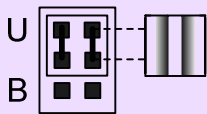
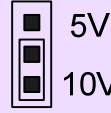
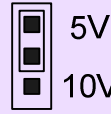
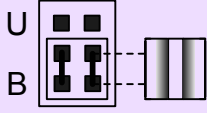
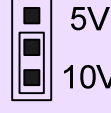
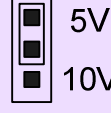
Signal Type	Polarity Setting (JP3)	Range Setting (JP4)
0~10V or 0~20mA		
0~5V or 0~10mA		
-10~+10V or -20~+20mA		
-5~+5V or -10mA~+10mA		

The default factory settings of 4A2D analogue input/output module are

Input code format – Bipolar(-8192~+8191)

Input signal type and range – Bipolar(-10V ~ +10V)

Output code format – Bipolar(-8192~+8191)

Output signal type and range – Bipolar(-10V ~ +10V)

For those applications that require the setting differ than the above default setting should make some modifications of jumper position according to above tables.

While application, besides the setting of jumper should be conducted, the AI module configuration of Winproladder also need to be performed.